

<https://doi.org/10.15407/ujpe66.9.761>

D. AYEHU, A. CHANE

Department of Physics, Wollo University

(P.O. Box 1145, Dessie, Ethiopia; e-mail: dslgnh0@gmail.com, alemuchane12@gmail.com)

THE EFFECT OF SUPERPOSITION ON THE QUANTUM FEATURES OF THE CAVITY RADIATION OF A THREE-LEVEL LASER

We study the statistical and squeezing properties of the cavity light produced by a degenerate three-level laser with the use of the solution of the pertinent quantum Langevin equation. Moreover, applying the density operator to the cavity radiation superposition, we investigated the quantum properties of the superposed cavity light beams generated by a pair of degenerate three-level lasers. Superposing the cavity radiation increases the mean and the variance of the photon number without affecting the quadrature squeezing. It is observed that the degree of squeezing of the separate cavity radiation, as well as the superposed cavity radiation, increases with the rate at which the atoms are injected into the cavity. We have also shown that the mean photon number of the superposed cavity radiation is the sum of the mean photon numbers of the individual cavity radiation. However, the variance of the photon number of the superposed cavity radiation turns out to be four times that of the component cavity radiation.

Keywords: superposition, squeezing, photon statistics.

1. Introduction

Quantum properties of the cavity radiation produced by various quantum optical systems have obtained a considerable attention in recent years [1–10]. One of such systems is a degenerate three-level laser. In it, the crucial role is played by the atomic coherence which can be introduced either by initially prepared three-level atoms injected into a cavity in a coherent superposition of the top and bottom levels [2–8, 10] or by coupling these levels by strong coherent light [9, 11–13]. When the atom decays from the top level to a bottom level via the intermediate level, two photons are produced. If these two photons have the same frequency, the three-level laser is referred to as degenerate. Otherwise, it is called non-degenerate. Recently, the atomic coherence was also induced by electrically pumped three-level lasers [1, 14]. We define a three-level laser as a quantum optical system in which the injected three-level atoms in a cascade configuration are initially prepared in a coherent superposition of the top and bottom levels and coupled to a vacuum reservoir via a single port mirror. A light mode to be in a squeezed state, if either the change in plus quadrature or the change in minus quadra-

ture is less than one. Because of a less noise in one quadrature component, the squeezed states of light have important applications in information processing systems like quantum computations [15], photon detection [16], and in the field of high-precision measurements [17].

Three-level lasers under certain conditions are good sources of squeezed light due to the correlation between the photons emitted from the top and intermediate levels, when the atom decays to the bottom level from the top-level via the intermediate level [10]. For instance, using the steady-state solution of the equation of evolution of the moments of the cavity mode operators, Alebachew [9] considered a three-level laser, where the atomic coherence is induced by initially prepared three-level atoms in a coherent superposition of the top and bottom levels, and the cavity modes are driven by coherent fields. He predicted that the system generates intensively entangled and two-mode squeezed light. On the other hand, the atomic coherence in a two-mode three-level cascade atomic system introduced by coupling the top and the bottom levels by an intense coherent field was studied in [19]. Squeezed states of light can also be realizable in two-level atoms. For example, Bashu and Kassahun [20] studied a cavity mode driven by

coherent light and interacting with a two-level atom, by employing the steady-state solution of the pertinent quantum Langevin equation. They found that the system generates squeezed light with the maximum quadrature squeezing being 50% below the shot-noise limit. In addition to three-level lasers and two-level atomic systems, the squeezed state of light can be generated by the quantum optical systems with parametric oscillation [21] and four-wave mixing [22].

In this work, we introduce a model that generates bright and squeezed light from a pair of degenerate three-level lasers. It has been shown for a long period that the three-level laser is a well-known source of squeezed light. In this contribution, we show that superposing the cavity radiations produced from a pair of degenerate three-level lasers substantially enhances the mean and the variance of the photon number. However, it has no effect on the quadrature squeezing. Applying the solution of the quantum Langevin equation, we first calculate the mean photon number, variance of the photon number, quadrature variance, and global and local quadrature squeezings of the individual cavity light beams. We will also analyze the squeezing and the statistical properties of a pair of the superposed cavity radiation from a pair of degenerate three-level lasers. Employing the density operator for the superposed cavity radiation, we calculate the mean and variance of the photon number, as well as the quadrature variance and global quadrature squeezing of the superposed cavity radiation. In particular, we are interested in the effect of superposing cavity light beams on the quantum features of the superposed cavity radiation.

2. Single Cavity Radiation

In this section, we demonstrate the quadrature squeezing and statistical properties of the cavity radiation produced by one of the three-level lasers.

2.1. The master equation

Here, we consider a three-level laser that consists of a cavity with degenerate three-level atoms in a cascade configuration. They are injected at a constant rate r_a into this cavity coupled to a vacuum reservoir and are removed after a large enough decay time τ . We denote the top, intermediate, and bottom levels of the three-level atoms by eigenkets $|a\rangle$, $|b\rangle$, and $|c\rangle$, respectively. We assume the cavity mode to be

at resonance with the two transitions $|a\rangle \rightarrow |b\rangle$ and $|b\rangle \rightarrow |c\rangle$, with the direct transition between $|a\rangle$ and $|c\rangle$ being dipole-forbidden. The Hamiltonian describing the interaction between a three-level atom and the cavity mode in the dipole and rotating wave approximations is expressible as

$$\hat{H} = ig[(|a\rangle\langle b| + |b\rangle\langle c|)\hat{a} - \hat{a}^\dagger(|b\rangle\langle a| + |c\rangle\langle b|)], \quad (1)$$

where g is the coupling constant between the three-level atom and the cavity mode, and \hat{a} is the annihilation operator for the cavity mode. We assume the initial state of a single three-level atom to be

$$|\psi_A(0)\rangle = C_a|a\rangle + C_c|c\rangle, \quad (2)$$

where C_a and C_c are the probability amplitudes for the atom to be initially in the top and bottom levels. The corresponding initial density operator is

$$\hat{\rho}_A(0) = \rho_{aa}^{(0)}|a\rangle\langle a| + \rho_{ac}^{(0)}|a\rangle\langle c| + \rho_{ac}^{(0)*}|c\rangle\langle a| + \rho_{cc}^{(0)}|c\rangle\langle c|, \quad (3)$$

where $\rho_{aa}^{(0)}$ and $\rho_{cc}^{(0)}$ are the probabilities of the three-level atom to be initially on the top and bottom levels, respectively, and $\rho_{ac}^{(0)}$ is the injected atomic coherence of the three-level atom. Moreover, we introduce a parameter η and relate the probability of the atom to be initially on the top level with this parameter as

$$\rho_{aa}^{(0)} = \frac{1 - \eta}{2}. \quad (4)$$

It then follows that

$$\rho_{cc}^{(0)} = \frac{1 + \eta}{2} \quad (5)$$

and

$$\rho_{ac}^{(0)} = \frac{1}{2}\sqrt{1 - \eta^2}. \quad (6)$$

Now with the aid of Eq. (1) and employing the linear and adiabatic approximation schemes, the master equation of the cavity mode is found, following the procedure presented in [23], to be

$$\begin{aligned} \frac{d\hat{\rho}}{dt} = & \frac{A\rho_{aa}^{(0)}}{2}(2\hat{a}^\dagger\hat{\rho}\hat{a} - \rho\hat{a}\hat{a}^\dagger - \hat{a}\hat{a}^\dagger\hat{\rho}) + \\ & + \frac{1}{2}(A\rho_{cc}^{(0)} + \kappa)(2\hat{a}\hat{\rho}\hat{a}^\dagger - \rho\hat{a}^\dagger\hat{a} - \hat{a}^\dagger\hat{a}\rho) + \\ & + \frac{A\rho_{ac}^{(0)}}{2}(\rho\hat{a}^{\dagger 2} + \hat{a}^{\dagger 2}\rho - 2\hat{a}^\dagger\hat{\rho}\hat{a}^\dagger) + \end{aligned}$$

$$+ \frac{A\rho_{ca}^{(0)}}{2}(\rho\hat{a}^2 + \hat{a}^2\rho - 2\hat{a}\rho\hat{a}), \quad (7)$$

in which

$$A = \frac{2g^2r_a}{\Gamma} \quad (8)$$

is the linear gain coefficient, Γ is the spontaneous decay constant taken to be the same for the transitions of the atom from $|a\rangle \rightarrow |b\rangle$ and $|b\rangle \rightarrow |c\rangle$, and κ is the cavity decay rate. We proceed to obtain the equation of evolution for the moments of the cavity mode variables. To this end, using the master equation, we readily get the following equations:

$$\frac{d}{dt}\langle\hat{a}(t)\rangle = -\frac{\lambda}{2}\langle\hat{a}(t)\rangle, \quad (9)$$

$$\frac{d}{dt}\langle\hat{a}^\dagger(t)\rangle = -\frac{\lambda}{2}\langle\hat{a}^\dagger(t)\rangle, \quad (10)$$

$$\frac{d}{dt}\langle\hat{a}(t)\hat{a}(t)\rangle = -\lambda\langle\hat{a}^2(t)\rangle + A\rho_{ac}^{(0)}, \quad (11)$$

$$\frac{d}{dt}\langle\hat{a}^\dagger(t)\hat{a}(t)\rangle = -\lambda\langle\hat{a}^\dagger(t)\hat{a}(t)\rangle + A\rho_{aa}^{(0)}, \quad (12)$$

$$\frac{d}{dt}\langle\hat{a}(t)\hat{a}^\dagger(t)\rangle = -\lambda\langle\hat{a}(t)\hat{a}^\dagger(t)\rangle + A\rho_{cc}^{(0)} + \kappa, \quad (13)$$

where

$$\lambda = A(\rho_{cc}^{(0)} - \rho_{aa}^{(0)}) + \kappa. \quad (14)$$

In view of Eq. (9), we can write

$$\frac{d}{dt}\hat{a}(t) = -\frac{\lambda}{2}\hat{a}(t) + \hat{F}(t), \quad (15)$$

where $\hat{F}(t)$ is the vacuum noise operator whose two-time correlation properties are given by [24]

$$\langle\hat{F}(t)\rangle = 0, \quad (16)$$

$$\langle\hat{F}^\dagger(t)\hat{F}(t')\rangle = A\rho_{aa}^{(0)}\delta(t-t'), \quad (17)$$

$$\langle\hat{F}(t)\hat{F}^\dagger(t')\rangle = (A\rho_{cc}^{(0)} + \kappa)\delta(t-t'). \quad (18)$$

2.2. Photon statistics

We now determine the mean and the variance of the photon number of one of the cavity radiation components. To this end, we represent the mean photon number of the cavity light as

$$\bar{n} = \langle\hat{a}^\dagger\hat{a}\rangle. \quad (19)$$

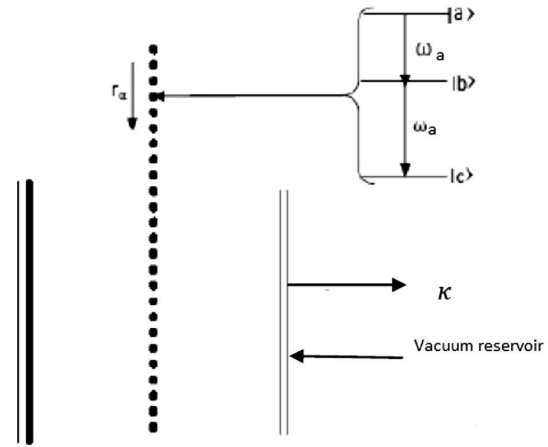

Fig. 1. Scheme of a degenerate three-level laser in the cascade configuration

In view of the solutions of Eq. (15) and its adjoint, the mean photon number takes the form

$$\bar{n} = \langle\hat{a}^\dagger(0)\hat{a}(0)\rangle e^{-\lambda t} + \int_0^t \int_0^t e^{-\frac{\lambda(2t-t'-t'')}{2}} \langle\hat{F}^\dagger(t'')\hat{F}(t')\rangle dt' dt''. \quad (20)$$

Let us carry out the integration and use the two-time correlation properties described in Eq. (17) along with the assumption that the cavity light is initially in a vacuum state. Then the mean photon number of the cavity light turns out to be

$$\bar{n} = \frac{A(1-\eta)}{2(A\eta + \kappa)}(1 - e^{-\lambda t}). \quad (21)$$

This result is identical to the expression obtained by Fessha [3] in the absence of the parametric interaction. It is clearly seen in Fig. 2 that the mean photon number of the cavity radiation is maximum, when the probabilities of the injected atoms to be initially in the top and bottom levels are equal. We also note that the mean photon number of the cavity radiation decreases with the atomic coherence and increases with the rate at which the atoms are injected into the cavity.

We now proceed to calculate the variance of the photon number for the cavity light coupled to the vacuum reservoir. The variance of the photon number for the cavity light reads

$$(\Delta n)^2 = \langle\hat{n}^2\rangle - \langle\hat{n}\rangle^2 \quad (22)$$

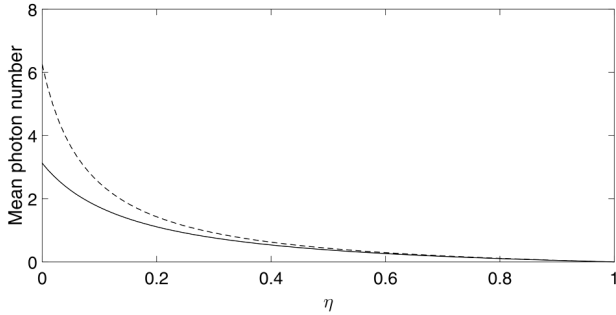

Fig. 2. Plots of the steady-state mean photon number versus η for $\kappa = 0.8$ and $A = 5$ (solid curve) and $A = 10$ (dashed curve)

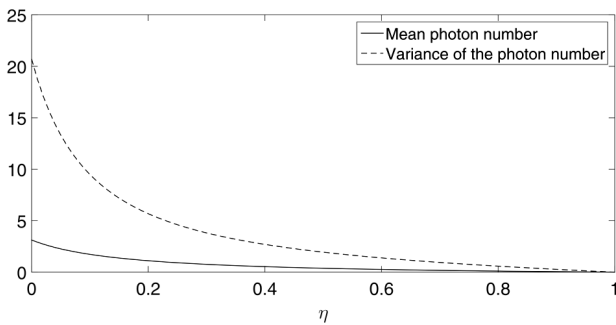

Fig. 3. Plots of the steady-state mean photon number \bar{n} (solid curve) and the variance in the photon number Δn^2 (dashed curve) versus η for $\kappa = 0.8$ and the linear gain coefficient $A = 5$

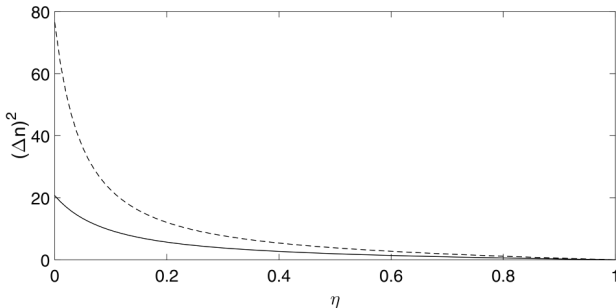

Fig. 4. Plots of the steady-state photon number variance $(\Delta n)^2$ versus η for $\kappa = 0.8$, $A = 5$ (solid curve), and $A = 10$ (dashed curve)

and can also be written as

$$(\Delta n)^2 = \langle \hat{a}^\dagger(t) \hat{a}(t) \hat{a}^\dagger(t) \hat{a}(t) \rangle - \langle \hat{a}^\dagger(t) \hat{a}(t) \rangle^2. \quad (23)$$

Since \hat{a} is a Gaussian variable with a vanishing mean, we have

$$(\Delta n)^2 = \langle \hat{a}^\dagger(t) \hat{a}(t) \rangle \langle \hat{a}(t) \hat{a}^\dagger(t) \rangle + \langle \hat{a}^{\dagger 2}(t) \rangle \langle \hat{a}^2(t) \rangle. \quad (24)$$

Employing the solution of the quantum Langevin equation and using the two-time correlation proper-

ties of the noise operators, we can easily show that

$$\langle \hat{a} \rangle = 0, \quad (25)$$

$$\langle \hat{a}(t) \hat{a}^\dagger(t) \rangle = \left(\frac{A(\eta - 1)}{2(A\eta + \kappa)} \right) e^{-\lambda t} + \frac{A(1 + \eta) + 2\kappa}{2(A\eta + \kappa)}, \quad (26)$$

$$\langle \hat{a}^2(t) \rangle = \frac{A(\sqrt{1 - \eta^2})}{2(A\eta + \kappa)} (1 - e^{-\lambda t}), \quad (27)$$

$$\langle \hat{a}^{\dagger 2}(t) \rangle = \frac{(A\sqrt{1 - \eta^2})}{2(A\eta + \kappa)} (1 - e^{-\lambda t}). \quad (28)$$

Now, by substituting the steady-state values of Eqs. (21), (26), (27), and (28) into Eq. (24), we have

$$\Delta n^2 = \frac{A(1 - \eta)}{2(A\eta + \kappa)} \frac{A(1 + \eta) + 2\kappa}{2(A\eta + \kappa)} + \frac{A^2(1 - \eta^2)}{4(A\eta + \kappa)^2}. \quad (29)$$

As can be seen from Fig. 3, the variance of the photon number is larger than the mean photon number. So, we realize that the cavity radiation exhibits super-Poissonian photon statistics. In Fig. 4, we plot the steady-state photon number variance of the cavity radiation against η . We see from this figure that the fluctuations of the photon number variance decrease with the parameter η . This implies that, like the mean photon number, the fluctuation of the photon number decreases with the atomic coherence. Moreover, it is observed from Fig. 4 that there is no photon number fluctuations of the cavity radiation at $\eta = 1$ regardless of the value of the linear gain coefficient, A . We then infer from this result that all the atoms are initially on the bottom level. Hence, there is no possibility for the emission of photons, as well as for photon number fluctuations.

We also note that the variance of the photon number increases with the linear gain coefficient, A .

2.3. Quadrature squeezing

We now analyze the squeezing properties of the cavity light produced by a degenerate three-level laser coupled to a vacuum reservoir. In order to investigate the squeezing properties, we firstly determine the quadrature variance of the cavity radiation generated by a three-level laser. To this end, the squeezing properties of the cavity light are described by two quadrature operators, defined as

$$\hat{a}_+ = \hat{a} + \hat{a}^\dagger \quad (30)$$

and

$$\hat{a}_- = i(\hat{a}^\dagger - \hat{a}). \quad (31)$$

The variances of the quadrature operators are defined by

$$(\Delta a_\pm)^2 = \langle \hat{a}_\pm^2 \rangle - \langle \hat{a}_\pm \rangle^2. \quad (32)$$

In view of Eqs. (30) and (31), we have

$$(\Delta a_\pm)^2 = \pm \langle \hat{a}^{\dagger 2} \rangle + \langle \hat{a}^\dagger \hat{a} \rangle + \langle \hat{a} \hat{a}^\dagger \rangle \pm \langle \hat{a}^2 \rangle. \quad (33)$$

Now, with regard for Eqs. (21), (26), (27), and (28), the quadrature variances take the form

$$\begin{aligned} (\Delta a_\pm)^2 &= \frac{A(1-\eta)}{2(A\eta+\kappa)}(1-e^{-\lambda t}) + \frac{A(\eta-1)}{2(A\eta+\kappa)}(e^{-\lambda t}) + \\ &+ \frac{A(1+\eta)+2\kappa}{2(A\eta+\kappa)} \pm \frac{A(\sqrt{1-\eta^2})}{(A\eta+\kappa)}(1-e^{-\lambda t}). \end{aligned} \quad (34)$$

In Fig. 5, the fluctuations in the minus quadrature are below the vacuum level with enhanced fluctuations in the plus quadrature. This shows that the cavity light is in a squeezed state, and the squeezing occurs in the minus quadrature. We next study the squeezing properties of the cavity radiation produced by a degenerate three-level laser coupled to a vacuum reservoir. We determine the quadrature squeezing of the cavity radiation in the entire frequency interval (the global quadrature squeezing) with respect to the quadrature variance of the vacuum state given as [1]

$$S = \frac{(\Delta a_-)_{\text{vac}}^2 - (\Delta a_-)^2}{(\Delta a_-)_{\text{vac}}^2}, \quad (35)$$

in which $(\Delta a_-)_{\text{vac}}^2$ is the quadrature variance of the vacuum state:

$$(\Delta a_-)_{\text{vac}}^2 = 1. \quad (36)$$

Thus, substituting Eqs. (34) and (36) into (35) leads to

$$S = 1 - \left(-\frac{A\sqrt{1-\eta^2}}{(A\eta+\kappa)} + \frac{A+\kappa}{A\eta+\kappa} \right). \quad (37)$$

Figure 6 illustrates the global quadrature squeezing as a function of the parameter η for different values of the linear gain coefficient. As can be seen from this figure, the cavity radiation is in a squeezed state for all values of η between 0 and 1. We also note that the

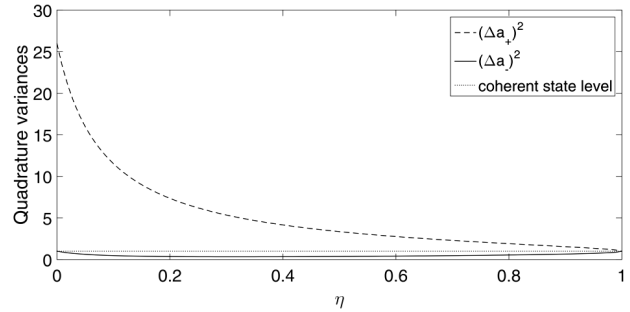

Fig. 5. Plots of the steady-state quadrature variance $(\Delta a_+)^2$ (dashed curve) and $(\Delta a_-)^2$ (solid curve) versus η for $\kappa = 0.8$ and $A = 10$

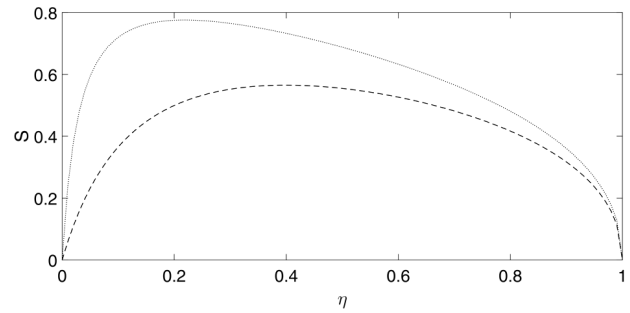

Fig. 6. Plots of the steady-state quadrature squeezing versus η for $\kappa = 0.8$, the linear gain coefficient $A = 5$ (dashed curve), and $A = 25$ (dotted curve)

quadrature squeezing of the cavity radiation increases with the rate at which the atoms are injected into a cavity. Moreover, it is not difficult to see from the trends in Fig. 6 that a substantial amount of squeezing can be obtained for small values of the parameter η and large values of the linear gain coefficient. The maximum quadrature squeezing of the cavity light for $\kappa = 0.8$ and $A = 25$ is 77.5% below the vacuum state level.

Here, we will calculate the quadrature squeezing of the cavity light in a given frequency interval (local quadrature squeezing). In order to do so, we firstly obtain the spectrum of quadrature fluctuations by the relation [14]

$$S_\pm(\omega) = \frac{1}{\pi} \text{Re} \int_0^\infty \langle \hat{a}_\pm(t), \hat{a}_\pm(t+\tau) \rangle_{ss} e^{i(\omega-\omega_0)\tau} d\tau, \quad (38)$$

in which ω_0 is the central frequency of the cavity radiation. The two-time correlation functions that appear in Eq. (38) can be written applying the relation [1]

$$\langle \hat{C}, \hat{D} \rangle = \langle \hat{C} \hat{D} \rangle - \langle \hat{C} \rangle \langle \hat{D} \rangle, \quad (39)$$

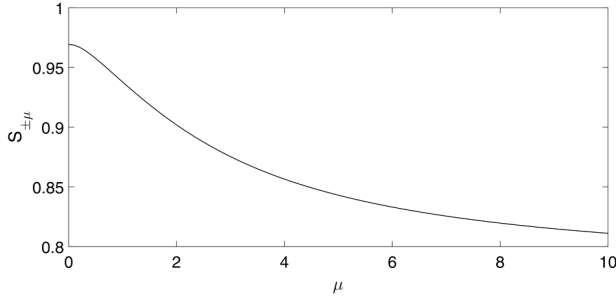

Fig. 7. The plot of local quadrature squeezing $S_{\pm\mu}$ versus μ for $\kappa = 0.8$, linear gain coefficient $A = 25$ and $\eta = 0.2024$

by the expression

$$\langle \hat{a}_{\pm}(t), \hat{a}_{\pm}(t + \tau) \rangle_{ss} = \langle \hat{a}_{\pm}(t) \hat{a}_{\pm}(t + \tau) \rangle_{ss} - \langle \hat{a}_{\pm}(t) \rangle_{ss} \langle \hat{a}_{\pm}(t + \tau) \rangle_{ss}. \quad (40)$$

Now, employing the solution of the quantum Langevin equation, we easily find the following two-time correlation functions:

$$\langle \hat{a}^{\dagger}(t) \hat{a}(t + \tau) \rangle_{ss} = \langle \hat{a}^{\dagger}(t) \hat{a}(t) \rangle_{ss} e^{-\lambda\tau/2}, \quad (41)$$

$$\langle \hat{a}^{\dagger}(t) \hat{a}^{\dagger}(t + \tau) \rangle_{ss} = \langle \hat{a}^{\dagger 2}(t) \rangle_{ss} e^{-\lambda\tau/2}, \quad (42)$$

$$\langle \hat{a}(t) \hat{a}^{\dagger}(t + \tau) \rangle_{ss} = \langle \hat{a}(t) \hat{a}^{\dagger}(t) \rangle_{ss} e^{-\lambda\tau/2}, \quad (43)$$

and

$$\langle \hat{a}(t) \hat{a}(t + \tau) \rangle_{ss} = \langle \hat{a}^2(t) \rangle_{ss} e^{-\lambda\tau/2}. \quad (44)$$

Thus, introducing Eqs. (41)–(44) into Eq. (40) along with Eq. (38) and performing the integration, we reduce the spectrum of the quadrature fluctuations to

$$S_{\pm}(\omega) = \frac{1}{\pi} (\Delta a_{\pm})^2 \left(\frac{\lambda/2}{(\lambda/2)^2 + (\omega - \omega_0)^2} \right). \quad (45)$$

The variances of the quadrature operators in the interval between $\omega' = -\mu$ to $\omega' = +\mu$ are given by

$$(\Delta a_{\pm})_{\pm\mu}^2 = \int_{-\mu}^{+\mu} S_{\pm}(\omega') d\omega'. \quad (46)$$

Introducing Eq. (45) into (46) and carrying out the integration, we get

$$(\Delta a_{\pm})_{\pm\mu}^2 = \frac{2}{\pi} (\Delta a_{\pm})^2 \tan^{-1} \left(\frac{2\mu}{\lambda} \right). \quad (47)$$

The local quadrature squeezing of the cavity light relative to the vacuum state is given by [1]

$$S_{\pm\mu} = \frac{(\Delta a_{-})_{\pm\mu\text{vac}}^2 - (\Delta a_{-})_{-\mu}^2}{(\Delta a_{-})_{\pm\mu\text{vac}}^2}, \quad (48)$$

where $(\Delta a_{-})_{\pm\mu\text{vac}}^2$ is the local quadrature variance of the vacuum state. This can be obtained by putting $r_a = 0$ in Eq. (47). So, we have

$$(\Delta a_{-})_{\pm\mu\text{vac}}^2 = \frac{2}{\pi} \tan^{-1} \left(\frac{2\mu}{\kappa} \right). \quad (49)$$

Thus, substituting Eqs. (47) and (49) into Eq. (48), we obtain

$$S_{\pm\mu} = 1 - \frac{\left(-\frac{A(\sqrt{1-\eta^2})}{A\eta+\kappa} + \frac{A+\kappa}{A\eta+\kappa} \right) \tan^{-1} \left(\frac{2\mu}{\kappa+A\eta} \right)}{\tan^{-1} \left(\frac{2\mu}{\kappa} \right)}. \quad (50)$$

In Fig. 7, we plot the local quadrature squeezing versus the frequency interval μ . As is displayed in this figure, the local quadrature squeezing of the cavity light is maximum for the value of the frequency interval close to 0. One can then see that a significant amount of squeezing is obtained for the frequency of the cavity radiation near to the central frequency. We can infer from this result that those cavity photons with frequencies closest to the central frequency are more squeezed than the rest of the cavity photons.

We recall that the maximum global quadrature squeezing of the cavity radiation is 77.5%, and the corresponding maximum local quadrature squeezing of the cavity radiation using the same parameters is found to 95.4% below the coherent state level. We thus see that the quadrature squeezing of the cavity radiation is raised by over 17% in the case of local quadrature squeezing. Moreover, we observe that, as the value of the frequency interval increases, the local quadrature squeezing decreases and tends to the global quadrature squeezing.

3. Superposition of a Pair of Radiation Beams

In this section, we investigate the statistical and squeezing properties of the superposed cavity radiation produced by a pair of degenerate three-level lasers.

First, we obtain the Q function of the cavity radiation employing the antinormally ordered characteristic function. We then determine the density operator for the superposed cavity radiation in terms of the Q function. With the aid of the resulting density operator, we calculate the mean and variance of the photon number, as well as the quadrature squeezing of the superposed cavity radiation. To this end, the antinormally ordered characteristic function is defined by

$$\Phi_a(z) = \text{Tr}(\hat{\rho} e^{-z^* \hat{a}} e^{z \hat{a}^\dagger}). \quad (51)$$

Employing the completeness relation together with the action of the annihilation operator for coherent states [1] for operators satisfying the commutation relation

$$[\hat{a}, \hat{a}^\dagger] = \mu', \quad (52)$$

the antinormally ordered characteristic function in terms of the Q -function can be written as

$$\phi_a(z) = \int d^2\beta \mu' Q(\mu'\beta) \exp(\mu'\beta^* z - \mu' z^* \beta), \quad (53)$$

in which

$$Q(\mu'\beta) = \frac{1}{\pi} \langle \beta | \hat{\rho} | \beta \rangle \quad (54)$$

is the Q function.

We now proceed to obtain an explicit expression for the Q and antinormally ordered characteristic functions. Assuming $\alpha = \mu'\beta$, the antinormally ordered characteristic function can be put in the form

$$\Phi_a(z) = \int \frac{d^2\alpha}{\mu'} Q(\alpha) \exp(\alpha^* z - z^* \alpha). \quad (55)$$

Because $\frac{Q(\alpha)}{\mu'}$ is the inverse Fourier transform of the antinormally ordered characteristic function, we get

$$Q(\alpha) = \frac{\mu'}{\pi^2} \int d^2z \phi_a(z) \exp(z^* \alpha - \alpha^* z). \quad (56)$$

Now, on applying the Baker–Hausdorff relation [25] to Eq. (51) along with Eqs. (21), (26), (27) and the fact that \hat{a} is a Gaussian variable with zero mean, we readily find the antinormally ordered characteristic function and the Q function to be

$$\phi_a(z) = \exp(-az^* z + b(z^2 + z^{*2})/2), \quad (57)$$

$$Q(\beta) = \frac{\mu'}{\pi} \left(\frac{1}{a^2 - b^2} \right)^{1/2} \exp\left(\frac{a\beta\beta^* + b(\beta^2 + \beta^{*2})/2}{a^2 - b^2} \right), \quad (58)$$

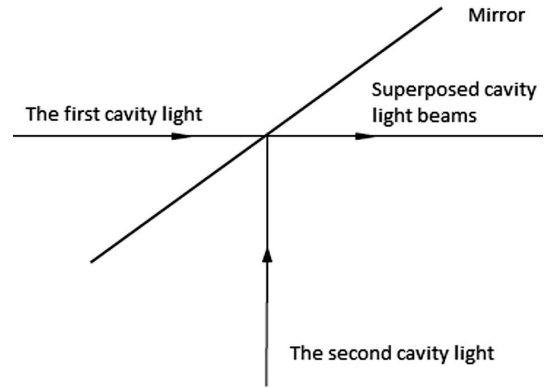

Fig. 8. Schematic representation of a pair of superposed identical light beams with $\kappa = 1$ for the upper surface of the mirror, and $\kappa = 0$ for the lower surface of the mirror

where

$$a = \frac{A(\eta - 1)e^{-\lambda t}}{(A\eta + \kappa)} + \frac{A(1 + \eta) + 2\kappa}{A\eta + \kappa} \quad (59)$$

and

$$b = \frac{A(\sqrt{1 - \eta^2})}{(A\eta + \kappa)} (1 - e^{-\lambda t}). \quad (60)$$

Let $\hat{\rho}'(\hat{a}^\dagger, \hat{a})$ be the density operator for one of the cavity light beam. Expanding this density operator in the normal order with regard for the completeness relation, we arrive at

$$\hat{\rho}' = \mu' \int d^2\alpha Q\left(\mu'\alpha^*, \mu'\alpha + \frac{\partial}{\partial\alpha^*}\right) \times \hat{D}(\alpha) |0\rangle \langle 0| \hat{D}(-\alpha). \quad (61)$$

Then the density operator for the superposition of the first of the light beams and another one is expressible as

$$\hat{\rho} = \mu'^2 \int d^2\gamma d^2\alpha Q\left(\mu'\gamma^*, \mu'\gamma + \frac{\partial}{\partial\gamma^*}\right) \times Q\left(\mu'\alpha^*, \mu'\alpha + \frac{\partial}{\partial\alpha^*}\right) |\alpha + \gamma\rangle \langle \alpha + \gamma|. \quad (62)$$

3.1. Photon statistics

We proceed to determine the mean and variance of the photon number of the superposed cavity light beams produced by a pair of degenerate three-level lasers coupled to a vacuum reservoir using the density operator for the superposed cavity light beams. To

this end, the mean photon number of a pair of superposed cavity light beams is expressible as

$$\bar{n}_s = \mu'^2 \int d^2\alpha d^2\gamma Q \left(\mu' \gamma^*, \mu' \gamma + \frac{\partial}{\partial \gamma^*} \right) \times \\ \times Q \left(\mu' \alpha^*, \mu' \alpha + \frac{\partial}{\partial \alpha^*} \right) Tr(|\alpha + \gamma\rangle\langle\alpha + \gamma| \hat{c}^\dagger \hat{c}), \quad (63)$$

where

$$\hat{c} = \hat{a} + \hat{b}, \quad (64)$$

with \hat{a} and \hat{b} being the annihilation operators for the cavity modes to be superposed. This can also be written as

$$\bar{n}_s = \frac{1}{\mu'} \int d^2\beta_1 Q \left(\beta_1^*, \beta_1 + \mu' \frac{\partial}{\partial \beta_1^*} \right) \beta_1 \beta_1^* + \\ + \frac{1}{\mu'} \int d^2\beta_2 Q \left(\beta_2^*, \beta_2 + \mu' \frac{\partial}{\partial \beta_2^*} \right) \beta_2^* \beta_2 + \\ + \frac{1}{\mu'} \int d^2\beta_1 Q \left(\beta_1^*, \beta_1 + \mu' \frac{\partial}{\partial \beta_1^*} \right) \beta_1 \times \\ \times \frac{1}{\mu'} \int d^2\beta_2 Q \left(\beta_2^*, \beta_2 + \mu' \frac{\partial}{\partial \beta_2^*} \right) \beta_2^* + \\ + \frac{1}{\mu'} \int d^2\beta_1 Q \left(\beta_1^*, \beta_1 + \mu' \frac{\partial}{\partial \beta_1^*} \right) \beta_1^* \times \\ \times \frac{1}{\mu'} \int d^2\beta_2 Q \left(\beta_2^*, \beta_2 + \mu' \frac{\partial}{\partial \beta_2^*} \right) \beta_2. \quad (65)$$

We note that an operator function $\hat{A}(\hat{a}^\dagger, \hat{a})$ can be expanded in the normal order in terms of the Q function as [1]

$$\langle \hat{A} \rangle = \frac{1}{\mu'} \int d^2\beta Q \left(\beta^*, \beta + \mu' \frac{\partial}{\partial \beta^*} \right) A_n(\mu' \beta^*, \mu' \beta). \quad (66)$$

The expression in Eq. (65) can then be written as

$$\bar{n}_s = \langle \hat{a}_1^\dagger \hat{a}_1 \rangle + \langle \hat{a}_2^\dagger \hat{a}_2 \rangle + \langle \hat{a}_1 \rangle \langle \hat{a}_2^\dagger \rangle + \langle \hat{a}_1^\dagger \rangle \langle \hat{a}_2 \rangle. \quad (67)$$

The fact that the Q -functions of the two-cavity radiation having identical frequencies are the same and Eq. (25) yield

$$\bar{n}_s = 2\langle \hat{a}^\dagger \hat{a} \rangle = 2\bar{n}, \quad (68)$$

in which \bar{n} is the mean photon number of one of the cavity radiation beams. We then see that the mean photon number of the superposed cavity radiation from a pair of degenerate three-level lasers is the sum of the mean photon numbers of the constituent cavity

radiations. We thus realize that one effect of superposing cavity radiation is to enhance the brightness of the superposed cavity radiation by a factor of 2. Now, in view of Eq. (21), the mean photon number of the superposed cavity radiation becomes

$$\bar{n}_s = \frac{A(1-\eta)}{(A\eta + \kappa)} (1 - e^{-\lambda t}). \quad (69)$$

We now calculate the variance of the photon number for the superposed cavity radiation using the density operator. The variance of the photon number of the superposed cavity light beams is expressible as

$$\langle \Delta n_s \rangle^2 = \langle \hat{c}^\dagger \hat{c} \hat{c}^\dagger \hat{c} \rangle - \langle \hat{c}^\dagger \hat{c} \rangle^2. \quad (70)$$

This can also be written as

$$\langle \Delta n_s \rangle^2 = \langle \hat{c}^{\dagger 2} \rangle \langle \hat{c}^2 \rangle + \langle \hat{c}^\dagger \hat{c} \rangle \langle \hat{c} \hat{c}^\dagger \rangle. \quad (71)$$

Applying the density operator for the superposed cavity light beams, we easily verify the following results:

$$\langle \hat{c}^{\dagger 2} \rangle = \frac{A(\sqrt{1-\eta^2})}{(A\eta + \kappa)} (1 - e^{-\lambda t}), \quad (72)$$

$$\langle \hat{c}^2 \rangle = \frac{A(\sqrt{1-\eta^2})}{(A\eta + \kappa)} (1 - e^{-\lambda t}), \quad (73)$$

and

$$\langle \hat{c} \hat{c}^\dagger \rangle = 2 + \frac{A(1-\eta)}{(A\eta + \kappa)} (1 - e^{-\lambda t}). \quad (74)$$

Substituting Eqs. (69), (72), (73), and (74) into (71), we find the photon number variance in the steady state to be

$$\langle \Delta n_s \rangle^2 = \frac{A^2(1-\eta^2)}{(A\eta + \kappa)^2} + \frac{A(1-\eta)}{(A\eta + \kappa)} \times \\ \times \left(\frac{2\kappa + A(1+\eta)}{A\eta + \kappa} \right) = 4(\Delta n)^2. \quad (75)$$

It is clearly seen from this expression that, unlike the mean photon number, the variance of the photon number of the superposed cavity light beams is not the sum of the variances of the photon numbers of each of the cavity light beams. Instead, the variances of the superposed cavity radiation from a pair of degenerate three-level lasers are enhanced by a factor of 4 relative to that of the photon number variance of one of the cavity light beams. Thus, we infer that superposing cavity radiation has a pronounced effect on the photon number fluctuations.

3.2. Quadrature Squeezing

We now investigate the squeezing properties of the superposed cavity radiation from a pair of degenerate three-level lasers. The quadrature operators of the superposed cavity radiation are defined by

$$\hat{c}_+ = \hat{c}^\dagger + \hat{c}, \quad (76)$$

$$\hat{c}_- = i(\hat{c}^\dagger - \hat{c}), \quad (77)$$

and the corresponding variances of the quadrature operators of a pair of superposed cavity radiation are given by

$$(\Delta c_\pm)^2 = \langle \hat{c}_\pm^2 \rangle - \langle \hat{c}_\pm \rangle^2. \quad (78)$$

This can also be put in the form

$$(\Delta c_\pm)^2 = \pm \langle \hat{c}^{\dagger 2} \rangle + \langle \hat{c}^\dagger \hat{c} \rangle + \langle \hat{c} \hat{c}^\dagger \rangle \pm \langle \hat{c}^2 \rangle. \quad (79)$$

Thus, the substitution of Eqs. (69), (72), (73), and (74) into (79) yields

$$(\Delta c_+)^2 = 2 + \left(\frac{2A(\sqrt{1-\eta^2})}{(A\eta + \kappa)} + \frac{2A(1-\eta)}{(A\eta + \kappa)} \right) (1 - e^{-\lambda t}), \quad (80)$$

$$(\Delta c_-)^2 = 2 + \left(\frac{2A(1-\eta)}{(A\eta + \kappa)} - \frac{2A(\sqrt{1-\eta^2})}{(A\eta + \kappa)} \right) (1 - e^{-\lambda t}). \quad (81)$$

Then, comparing Eq. (34) with Eqs. (80) and (81), we get

$$(\Delta c_\pm)^2 = 2(\Delta a_\pm)^2. \quad (82)$$

Based on this expression, we see that the quadrature variance of the superposed cavity radiation is the sum of the quadrature variances of each of the cavity radiation components.

Let us consider the quadrature squeezing of a pair of superposed cavity radiation beams. For $r_a = 0$, the quadrature variance of the superposed cavity light beams reduces to

$$(\Delta c_-)_{\text{vac}}^2 = 2. \quad (83)$$

The quadrature squeezing of a pair of superposed cavity light beams relative to the quadrature variance of the superposed vacuum state is given by

$$S = \frac{(\Delta c_-)_{\text{vac}}^2 - (\Delta c_-)^2}{(\Delta c_-)_{\text{vac}}^2}. \quad (84)$$

Then, introducing Eq. (81) and (84), we find

$$S = 1 - \left(1 + \frac{A(1-\eta)}{(A\eta + \kappa)} - \frac{A(\sqrt{1-\eta^2})}{(A\eta + \kappa)} \right) (1 - e^{-\lambda t}). \quad (85)$$

In view of Eq. (37) and (85), we note that the global quadrature squeezing of the superposed cavity light beams is equal to that of the individual cavity light beams. We note that superposing the cavity light beams does not affect the quadrature squeezing. We realize that the quadrature squeezing is an intrinsic property of the cavity radiation.

4. Conclusions

We have studied the quantum properties of the separate and superposed cavity radiation beams generated by degenerate three-level lasers coupled to a vacuum reservoir. Applying the solution of the quantum Langevin equation, we have determined the quantum properties of one of the cavity radiation beams. In addition, applying the density operator to the superposed cavity radiation produced by a pair of degenerate three-level lasers, we have investigated the statistical and squeezing properties of the superposed cavity radiation. We have observed that the mean and the variance of the photon number, as well as the quadrature squeezing of the cavity light, increase with the linear gain coefficient, A . We also found that the cavity radiation exhibits super-Poissonian photon statistics. Moreover, we have shown that the maximum global and local quadrature squeezings of the cavity light to be 77.5% and 95.4% below the coherent state level, respectively. In addition, the local quadrature squeezing approaches the global quadrature squeezing in the limit of a large frequency interval. Furthermore, it has been proved that the mean photon number of the superposed cavity light beams is a simple sum of the mean photon numbers of the cavity light beams, and the variance of the photon number for superposed cavity light beams is four times that of the variance of an individual cavity light beam. We have also found that superposing the identical cavity light beams does not affect the quadrature squeezing.

1. Fesseha Kassahun. *Refined Quantum Analysis of Light* (Create Space Independent Publishing Platform, 2014).
2. M.O. Scully, K. Wodkiewicz, M.S. Zubairy, J. Bergou, N. Lu, J. Meyer ter Vehn. Two-photon correlated-sponta-

- neous-emission laser. Quantum noise quenching and squeezing. *Phys. Rev. Lett.* **60**, 1832 (1988).
3. K. Fesseha. Three-level laser dynamics with squeezed light. *Phys. Rev. A* **63**, 033811 (2001).
 4. N. Lu, F. Zhao, J. Bergou. Nonlinear theory of a two-photon correlated-spontaneous-emission laser: A coherently pumped two-level-two-photon laser. *Phys. Rev. A* **39**, 5189 (1989).
 5. N. Lu, S. Zhu. Quantum theory of two-photon correlated-spontaneous-emission lasers. Exact atom-field interaction Hamiltonian approach. *Phys. Rev. A* **40**, 5735 (1989).
 6. S. Tesfa. Entanglement amplification in a nondegenerate three-level cascade laser. *Phys. Rev. A* **74**, 043816 (2006).
 7. T. Abebe. Enhancement of squeezing and entanglement in a non-degenerate three-level cascade laser with coherently driven cavity. *Ukr. J. Phys.* **63**, 733 (2018).
 8. D. Ayehu. Quantum properties of correlated emission laser with dephasing and phase fluctuation. *Results in Physics* **28**, 104567 (2021).
 9. E. Alebachew, K. Fesseha. A degenerate three-level laser with a parametric amplifier. *Opt. Commun.* **265**, 314 (2006).
 10. D. Ayehu. Squeezing and entanglement properties of the cavity light with decoherence in a cascade three-level laser. *J. Russ. Laser Res.* **42**, 136 (2021).
 11. N.A. Ansari. Effect of atomic coherence on the second-and higher-order squeezing in a two-photon three-level cascade atomic system. *Phys. Rev. A* **48**, 4686 (1993).
 12. N.A. Ansari, J. Gea-Banacloche, M.S. Zubairy. Phase-sensitive amplification in a three-level atomic system. *Phys. Rev. A* **41**, 5179 (1990).
 13. M. Molla Gessesse. The noise effect of vacuum reservoir on the dynamics of three-level laser pumped by coherent light. *Ukr. J. Phys.* **65**, 385 (2020).
 14. F. Kassahun. Three-level laser dynamics with the atoms pumped by electron bombardment. <https://arXiv:1105.1438v3> quant-ph (2012).
 15. S. Lloyd, S.L. Braunstein. Quantum computation over continuous variables. *Phys. Rev. Lett.* **82**, 1784 (1999).
 16. C.M. Caves. Quantum-mechanical noise in an interferometer. *Phys. Rev. D* **23**, 1693 (1981).
 17. J.M. Xiao, L.A. Wu, H.J. Kimble. Precision measurement beyond the shot-noise limit. *Phys. Rev. Lett.* **59**, 276 (1987).
 18. E. Alebachew. Bright entangled light from two-mode cascade laser. *Opt. Commun.* **281**, 6124 (2008).
 19. M.O. Scully. Correlated spontaneous-emission lasers: Quenching of quantum fluctuations in the relative phase angle. *Phys. Rev. Lett.* **55**, 2802 (1985).
 20. B. Bashu, F. Kassahun. Quadrature squeezing in the cavity mode driven by coherent light and interacting with two-level atom. *Int. J. Mol. Theor. Phys.* **3**, 1 (2019).
 21. G.J. Milburn, D.F. Walls. Production of squeezed states in a degenerate parametric amplifier. *Opt. Commun.* **39**, 401 (1981).
 22. D.F. Walls, G.J. Milburn. *Quantum Optics*. (Springer, 1995).
 23. E. Alebachew. Enhanced squeezing and entanglement in a non-degenerate three-level cascade laser with injected squeezed light. *Opt. Commun.* **280**, 133 (2007).
 24. Marlan O. Scully, M. Suhail Zubairy. *Quantum Optics* (Cambridge Univ. Press, 1997).
 25. S.M. Barnett, P.M. Radmore. *Methods in Theoretical Quantum Optics* (Oxford Univ. Press, 1997).

Received 01.10.20

Д. Аеху, А. Чейн

ВПЛИВ СУПЕРПОЗИЦІЇ НА КВАНТОВІ ВЛАСТИВОСТІ ВИПРОМІНЮВАННЯ З ПОРОЖНИНИ ТРИРІВНЕВОГО ЛАЗЕРА

Досліджено статистичні властивості і стиснення світла, що випромінюється з порожнини за допомогою трирівневого лазера, на основі розв'язку відповідного квантового рівняння Ланжевена. Крім того, застосовуючи оператор густини до суперпозиції випромінювання з порожнини, ми вивчили квантові властивості суперпозиції променів світла від двох вироджених трирівневих лазерів. Суперпозиція випромінювання з порожнини збільшує середнє значення і дисперсію числа фотонів, не змінюючи квадратурного стиснення. Показано, що ступінь стиснення незалежного і змішаного випромінювання зростає зі збільшенням швидкості інжектування атомів у порожнину. Ми також знайшли, що середнє число фотонів суперпозиції дорівнює сумі середніх для окремих компонент, тоді як дисперсія числа фотонів при суперпозиції зростає в чотири рази.

Ключові слова: суперпозиція, стиснення, статистика фотонів.