

A STUDY OF DEVICES USED FOR GEOMETRIC PARAMETER MEASUREMENT OF ENGINEERING BUILDING CONSTRUCTION

<https://doi.org/10.23939/istcgcap2018.01.021>

The aim. To study the abilities of electronic tacheometers to control geometric parameters of engineering constructions. **Methods.** The analysis of standard-setting documents for conducting geodetic works in industrial production and construction was carried out. The methods and devices used for this purpose were explored. **Results.** It is proposed to use electronic tacheometer and special methodology for such tasks. For this purpose, the research of a distance-measuring theodolite of an electronic tacheometer was conducted. In order to control the measurement of distances directly on the construction site, a 10-meter invar wire stand was developed, which was previously tested at the 1st-grade standard in the research institute of metrology with an accuracy of no greater than 0.01 mm. The method of transmission of reference distances, where special spheres and geodetic points are fixed by an aperture were developed. For direct measurements of the sections, the method of invar wire tensing was investigated, and mechanical balancing of the weighing system was performed. The control of the instrument's angular values was fulfilled on a higher-order metrological installation. The influence of non-perpendicular axes and eccentricity on the accuracy of angles measurement was established. To optimize pointing at a reflective mark, the design of the mark and the special bracket, which with the accuracy of not worse than 100, orientates the mark perpendicularly to the light beam of an electronic tachometer, was researched. The triple prism was also investigated, the relationship between height, diameter and reflection center was established. The design of a spherical reflector and a stand for laying runs with compensation of centering, reduction, and heights measurement of a device-reflector was developed. The construction of a bracket (vector) with two reflectors for the measurement work was developed. A three-dimensional model of an industrial object for optimal planning of places for fixing a geodetic basis and transition points of an electronic tacheometer was elaborated. **Scientific novelty.** The method of balancing forces in a geodetic tripod can be considered as the basis for the initiation of an automated centering of a device. Optical calculation of a triple prism can be used to determine a permanent of a geodetic device without measurements on the basis. The calculation of the optimal geodetic mark image provides unambiguous visibility and increases the accuracy of angular measurements. **Practical significance.** Using the developed method, it is possible with the help of any tacheometer to determine the spatial coordinates of an engineering construction with control and optimal accuracy.

Key words: technical measurements, precision measurements, standard linear basis, study of electronic tacheometers, instrument correction, linear angular measurements, optimization of geodetic measurements.

Introduction

Modern development of some fundamental branches of science and spheres of the economy lead to the necessity of constructing unique structures and installment of scientific and technological equipment with high precision. These structures include: linear and ring nuclear accelerators, large radio telescopes and antenna complexes, automated production lines, and other special structures. Normal functioning of such apparatus during their operation is only possible with high accuracy with the connection of elements of building structures and the technological equipment.

During construction and operation of civilian high rise buildings, large industrial buildings, nuclear and thermal power plants, large reactors, bridge transitions, radio-antenna complexes, and

installations of technological equipment, high-precision geodetic measurements are also performed. The parameters of structures subject to control in metallurgy, engineering, energy, transport, and civil engineering have dimensions of up to hundreds of meters, and the precision for their control is from 0.02 to 0.5 mm [Baran, 2012].

The problem of increasing the geometric accuracy during construction of engineering structures led to the need to develop new methods of engineering and geodetic works and control and assembly measurements. These issues are relevant to the improvement of the methods of constructing planed-high-altitude backbone geodetic networks.

The standards for the accuracy of the work and the choice of instruments are regulated by the normative documents of Ukraine [National Building Regulations (DBN), 2010, National Standards of Ukraine (DSTU-N), 2009]. We will also consider

some of the standards of European requirements in this field [ISO, 2014, ISO, 2015].

Let us take a closer look at National Standards of Ukraine [DSTU-N, 2009], where the key element is the allowance – the absolute value of the difference between the boundary values of the geometric parameter. The allowance is set and depends on the nominal dimensions of the part and the accuracy class.

$$\Delta x = i \cdot k, \quad (1)$$

where i – the unit of allowance (the value of the interval being measured), k – the coefficient of accuracy.

There are nine allowances:

- *manufacturing of building construction*:
 - 1) Linear sizes;
 - 2) Linearity;
 - 3) Perpendicularity;
 - 4) Diagonal uniformity;
- *geodetic marking*:
 - 5) Marking points and axes in plan;
 - 6) Rendering points and vertical axes, as well as pivoting points,
 - 7) Marking and transfer of altitude marks;
- *installation and construction work*:
 - 8) Landmarks adjustment;
 - 9) Installation symmetry.

There are six classes of accuracy: two for metal construction as well as for reinforced concrete and brick constructions.

An absolute margin of error is distinguished, which is normalized, and an actual margin of error is obtained from measurements. For a measured parameter to correspond to a certain accuracy class, the actual margin of error must be less than the absolute. The absolute margin of error is linearly dependent on allowance:

$$dx_{me} = K \cdot \Delta x, \quad (2)$$

where K – coefficient, that depends on the purpose of measurement and the nature of the object.

Thus, for the measurement performed under the control of the accuracy of the elements manufacturing and installation, as well as the accuracy control of the marking works, $K = 0.2$ is taken. For the measurement, performed in the course of marking works, $K = 0.4$ is taken.

The measurements of the mean square error is obtained directly with a confidence probability $P = 0.988$ linearly depends on the actual margin of error:

$$dx_{mse} = \frac{dx_{ep}}{2,5}. \quad (3)$$

Table 1 shows the value of allowances and errors for the first, third, and fifth classes of accuracy at $K = 0.2$ for a four-meter component.

Since the construction may consist of several components, the concept of functional allowance, that is a system of modules (a set of rules for the interconnection of the dimensions of volumetric-planning or structural elements of buildings and structures), is introduced in the standard [DSTU-N, 2009]. Also, the notion of a dimension chain is introduced – a set of dimensions that forms a closed loop, which is directly used in solving the problems of construction technology.

Analyzing Table 1, we conclude that the accuracy requirements for the mean square error is from 0.02 mm to 5 mm for the various classes of accuracy and different allowances are quite high.

Table 1

Allowances and errors for the first, third, and fifth classes of accuracy at $K = 0,2$

№ Allowance	Δx , mm			dx_{ep} , mm			$dx_{cкн}$, mm		
	1	3	5	1	3	5	1	3	5
Accuracy class									
1	0.2/1.0/6.0			0.04/0.2/1.2			0.02/0.1/0.5		
2	1.0/6.0/38			0.2/1.2/7.6			0.1/0.5/3.0		
3	0.2/1.6/10			0.04/0.3/2.0			0.02/0.1/0.8		
4	1.0/6.0/38			0.2/1.2/7.6			0.1/0.5/3.0		
5	0.2/1.4/9.6			0.04/0.3/1.9			0.02/0.1/0.8		
6	0.2/0.6/3.8			0.04/0.1/0.8			0.02/0.04/0.3		
7	0.2/1.0/6.4			0.04/0.2/1.3			0.02/0.1/0.5		
8	1.5/9.6/64			0.3/1.9/13			0.1/0.8/5.2		
9	0.6/3.6/26			0.12/0.7/5.2			0.05/0.3/2.1		

In Ukraine, where the production of high precision geodetic equipment is not implemented practically, the classic approach to controlling the geometric parameters of engineering structures is predominantly used. Thus, in the scientific works of Borovyi and Baran [Borovyi, 2017, Baran, 2012], the control of geometric parameters is performed by the following methods:

Verification of linearity is performed by string, string-optical, optical micrometry, indicator, collimation, autocollimation, auto-reflection, and interference methods. The basis of these methods is the construction of a pivot and the measurement of deviations in relation to it by special devices such as alinometers.

Verification of axial alignment is performed by placing rectilinear structures in relation to a pivot in the two planes. Theodolites and roulettes are used.

Horizontal verification is completed by a horizontal leveling method with an improved mechanism. Geodetic levels are used.

Verification of the high-altitude position of structures uses the method of geometric, hydrostatic, and micro leveling.

Verification of the slope is performed by the method of leveling and a sloping pivot. In this case, levels and optical quadrants are used.

Vertical verification uses the method of a mechanical vertical, optical vertical, and of a vertical reference plane. Instruments of vertical projection are applied. For example, to control the verticality of shafts in ionization channels of the nuclear power plant, and the linearity of the beams of suspension cranes, it is necessary to issue modern vertical projection devices with a micrometer nozzle.

Verification of parallelism uses the method of side leveling. The instruments used are inside gauges and roulettes.

Verification of perpendicularity applies the method of determining the horizontal angle between two flat structures. Theodolite and electronic tacheometer are used.

Verification of plane is conducted by the method of leveling the surface. The devices used in this case are a geodetic level, camera, electronic tacheometer, and a laser scanner.

Verification of curvilinearity applies the method of rolling and encircling. Inside gauges and roulettes are used.

In the works of Burak and Voitenko [Burak, 2010, Voitenko, 2011], the use of electronic tacheometers for the observation of complex engineering constructions was proposed.

It should be noted that the European practice of execution of such works differs from ours. With access to the development of specialized equipment, their engineers, for virtually every measuring task, create a unique device and offer measurement techniques. For example, in the works of Werner and Bihter [Werner, 2017, Bihter, 2010], it is recommended to use special equipment such as inclinometers, laser trackers, and scanners, to determine the geometric parameters and study the stability of the spatial-temporal position of building structures.

The world-renowned TESA Company, Switzerland, and the newly formed Ukrainian company Microtech PNPP for high-precision measurements, offer to use modern dash devices equipped with an electronic display and automated counting. These devices are high-precision and can be used only for small linear objects. Main technical characteristics include: range of work in terms of distance is 0–0,3 m,

measuring speed – 1/5 s, accuracy of measurements $\pm 0,05$ mm.

3D scanners should also be used for high-precision engineering measurements [Romanishin, 2012]. The essence of terrestrial laser scanning means measuring distances from the scanner to the points of the object at high speed and registration of the corresponding directions (vertical and horizontal angles). The principle of the object's general mapping, not its individual points, is used. Therefore, a terrestrial laser scanner can be characterized as a mapping measuring system, the work result of which is a three-dimensional image, the so-called scan (cloud of points). The representation of the results of terrestrial laser scanning is an array of laser reflection points from objects in the field of view of the scanner, with five characteristics, namely spatial coordinates (X, Y, Z), intensity and color. Main technical characteristics include: range of work in terms of distance is 0.6–130 m, measuring speed – 976000/1 s, accuracy of measurements ± 2 mm.

The principle of a laser tracker operation in the geometric sense is the same as of a laser scanner. The device measures horizontal, vertical angles and spatial distances. In the physical sense, the device is more perfect, and as a result more accurate. The scientific work [LEICA, 2014] presents the use of a laser tracker for virtually all measurements.

Main technical characteristics include: range of work in terms of distance is 0–80 m, measuring speed – 16 000/1 s, accuracy of measurements – $16 \mu\text{m} + 0,8 \mu\text{m}/\text{m}$.

Coordinate-measuring machines are high-tech and precise. They are the systems that have six degrees of freedom with three directions of the axes and three turning corners. In determining the coordinate system, the parameters of the degrees of freedom, which are stored in the program for coordinate transformation, are calculated. Control points (geodetic points) are used to set the external coordinate system. The general principle of the coordinate-measuring machine's operation is that the object is measured by a spherical probe. During each contact to the surface, the coordinates are read along the directions of the X, Y, Z axes. The coordinates of the points defined by the probe are transmitted to the computer for analysis. Before the measurements are performed, the calibration of a probe, as well as determining its diameter and distance along the axes X, Y, Z from the base point, are carried out.

Before measuring a component, the coordinate system in which all calculations will be performed is determined. The coordinate system is usually defined on the basis of a technical drawing of, for example, planes, cylinders, cones, or control points on surfaces of arbitrary shape.

Main technical characteristics include: range of work in terms of distance is 0–3.7 m, measuring speed –1/1 s, accuracy of measurements – 6 μm .

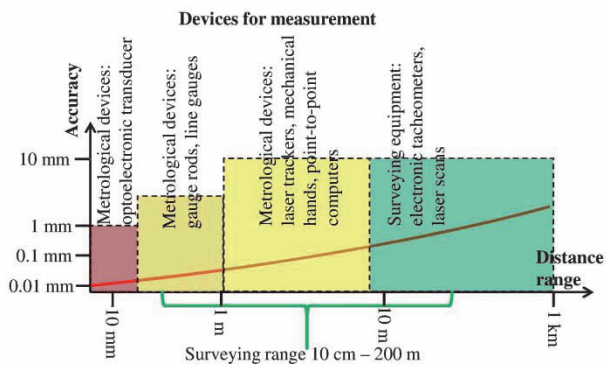

Fig. 1. Measurement technology integrated graph

From the analysis of the listed geodetic systems for the measurement of building structures a schematic diagram (Fig. 1) is compiled, in which the indicated instruments for measuring, their accuracy, and range of distances are shown.

Electronic tacheometers are predominantly used in Ukraine, thus there is a need to take a closer look at their capabilities.

Aim

To study the possibilities of electronic tacheometers for the control of geometric parameters of engineering constructions.

Methods

It is proposed to consider the measuring system to determine the geometric parameters of engineering construction (Fig. 2), which include an electronic tacheometer, a single prism transducer, a spherical transducer, a dual prism transducer (vector), and a mini tripod.

For further research we will use the electronic tacheometer Leica TCR1201 R300 with the following basic technical characteristics: accuracy of distance measurement is 1 mm +1 ppm, accuracy of angles measurement – 1".

The advantages of this measurement system over the ones mentioned above are obvious: mobility, a large range of distance measurement, and lower costs.

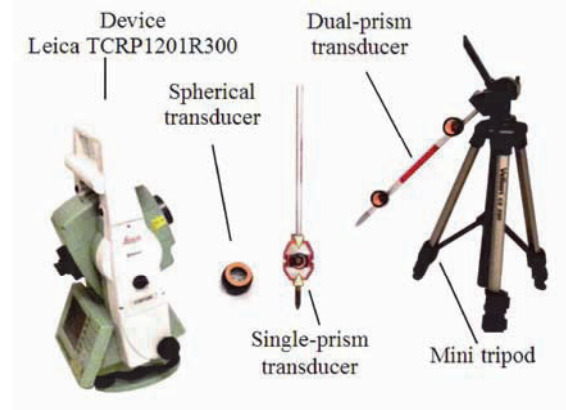

Fig. 2. Measurement system for determining the geometric parameters of building construction

Concerning the determination of the measurement accuracy, this question requires additional research, because in this case it is necessary to take into account several factors: firstly, direct measurements of horizontal, vertical angles and distances that are carried out under complicated industrial conditions, which affect observance of the accuracy of measurements; secondly, the accuracy depends on the binding to the original geodetic basis (network configuration); thirdly, the direct accuracy determination of the spatial coordinates of the measuring object.

The control of the angle measuring part of the electronic tacheometer Leica TCR1201 R300 is carried out on "VETU" 01-03-05-98 "AUPNT" autocollimating installation designed to determine and control the metrological characteristics of geodetic instruments, namely optical and laser levels, theodolites, vertical projection devices. and the angle measuring part of optical and electronic tacheometers (Fig. 3). The average square error of the angle of 180° reproduction by autocollimating "AUPNT" sight tubes in the vertical and horizontal planes does not exceed 0,7". We performed six measuring methods, determined the impact of eccentricities and non-perpendicularity of the axes on the accuracy of the angles, and the mean square error of measurement of the horizontal and vertical angles was determined.

To enter an electronic tacheometer into the coordinate system of an engineering structure or a large-sized component, it is necessary to perform collimating and measuring for at least two points.

According to V. Bolshakov [Bolshakov, 1976], the most precise visual focusing can be performed on a single bar, with which the horizontal and vertical lines of the net of threads are aligned. To optimize the geodetic mark in order to

accurately collimate the mark on the drawing, the intersection of the two lines should be depicted. However, given the problem of ensuring the perpendicularity of the mark plane to the beam, the intersection of the lines is better to replace it with the point of a certain diameter.



Fig. 3. Installation of "AUPNT"

Let us consider our argument in more detail. For this we use the Rayleigh resolution formula (Rayleigh's Criterion for resolution). It relates to the same extent to all devices, because it is predetermined by the resolution of the eye. We see two points separately if they are perceived by different photosensitive cells on the retina of the eye. And this happens when the center of the diffraction disk of the one coincides with the minimum on the diffraction pattern of the second. In other words, the condition or the limit of resolution (the ability to see separately) is the angular half-width of the first diffraction minimum from the gap.

There are two resolutions distinguished. Linear resolution is the minimum distance between two separate point objects, in which they are perceived as separate objects that do not merge. Angular resolution is the minimum angle between point objects, when they are still perceived as separate objects. The resolution of optical devices is limited by both the fundamental physical laws (for example, diffraction of light), as well as the imperfection of the device.

Thus, according to Bolshakov [Bolshakov, 1976], the condition of optical resolution is written as:

$$\frac{d}{D} = 1.22 \frac{\lambda}{a}, \tag{4}$$

where $\lambda = 570$ nm, the average wavelength of optical range, $a = 2$ mm, the mean diameter of the human eye pupil, d is the distance between the two

points on which they are observed as separate, D is the distance from the observer to the surveying target.

Having entered into (1) the value ρ – the number of seconds in the radian and v – the increase of the sight tube, we obtain the formulas for determining the limiting resolution while collimating with the naked eye and with a sight tube:

$$\frac{d}{D} = 1.22 \frac{\lambda \cdot \rho}{a}, \tag{5a}$$

$$\frac{d}{D} = 1.22 \frac{\lambda \cdot \rho}{a \cdot v}. \tag{5b}$$

We substitute the values in the given formulas, bringing them to the same units – meters:

$$\left(\frac{d}{D}\right)_{Eye} = 1.22 \frac{0.00000057 \cdot 206265}{0.002} = 71.71;$$

$$\left(\frac{d}{D}\right)_{Sighttube} = 1.22 \frac{0.00000057 \cdot 206265}{0.002 \cdot 30} = 2.4.$$

We calculate the boundary resolution d for different distances D . The results obtained are given in the table. These calculations are confirmed by the results of the visual acuity test of Golovin-Sivtsev [Chyzh, 2013], where it is considered that a person has a "perfect" sight if he/she can read the row from a distance of 5 meters, while the distance between the elements is 3 mm. Fig. 4 graphically shows the values of Table 2 for the 30* sight tube.

Table 2

Limiting linear resolution at different distances for an eye and a sight tube with an increase of 30*

<i>D, m</i>	5	10	20	30	40	50
<i>d, mm eye</i>	1.7	3.5	7	10.5	14	17.5
<i>d, mm S.T.</i>	0.06	0.1	0.2	0.4	0.5	0.6

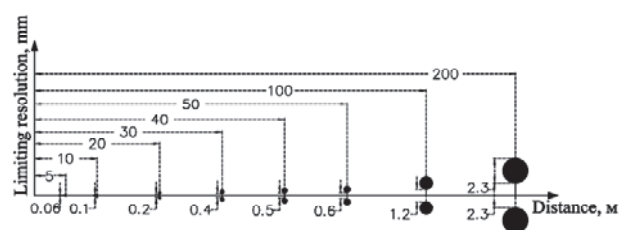

Fig. 4. Limiting linear resolution at different distances for a sight tube with an increase of 30*

Based on theoretical calculations, we proposed an optimal image of the geodetic mark for collimation at various distances, which is presented in Fig. 5.

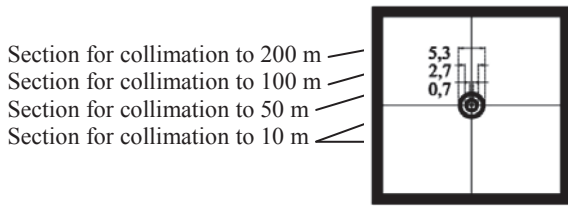

Fig. 5. Optimum image of a mark for accurate collimating at different distances

Concerning the reflective material, in the work of Lambin [Lambin, 2011], light reflective films based on microprisms were investigated, which found that the fairness and accuracy of the distance measurement and the angles on the film reflectors depend on the perpendicularity of the reflecting surface to the visor plane of the beam.

In order to ensure high accuracy of measurements, and compensate for the error of non-perpendicularity, it is proposed to start the measuring geodetic work with planning in three-dimensional space. For this purpose, a three-dimensional holder was developed, Fig. 6.

A spherical reflector and a stand were also developed for the transfer of the geodesic basis coordinates from the original basis to the points of measurement of the building structure, in the process of which compensates for the errors of centering, reduction, and height measurements, see Fig. 7.

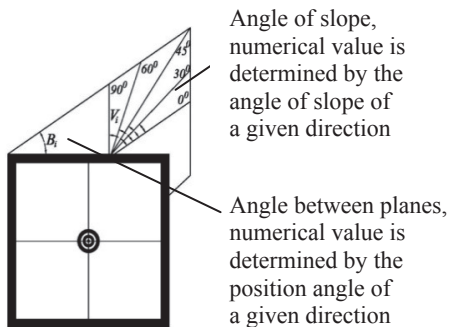

Fig. 6. Three-dimensional holder

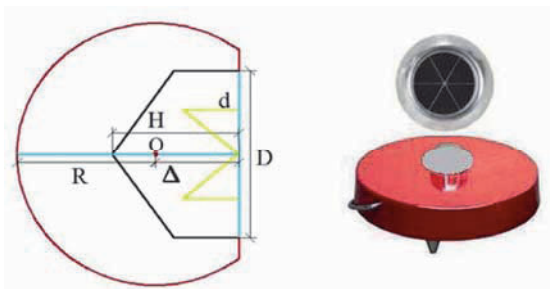

Fig. 7. A spherical reflector and a stand

The main elements of the manufactured reflector are a triangle of optical glass BK7 with parameters: diameter – D, height – H, distance – Δ from the entrance border to the center of reflection – O and d – path of light beam in a triple prism. Also, the metal sphere with the parameters: R – radius and center – O. Dependences were used to calculate the parameters of the reflector. [Rusynom, 1963]:

$$\Delta = \frac{H}{1.5163}, \quad (6)$$

$$d = \frac{D}{2} \sqrt{3}. \quad (7)$$

The following values were obtained for the spherical reflector we designed: D = 40.6 mm, H = 29.1 mm, Δ = 19.19 mm, d = 35.16 mm.

To control the distance measuring component, a working ten-meter standard unit of length from the invar wire and two scales, as well as a tensioning and balancing system were made.

An installation kit for measuring 10-meter segments is shown in Fig. 8.

The actual value of the length of the working standard was determined on “BETU” 01-03-05-98. It needs to be noted that the transfer of the unit size of the working standard to the standard measuring tape of the 2nd level and the working means of measuring equipment, namely the meters of linear displacements and measuring wires up to 24 m, can be carried out by direct measurement in accordance with the National Standards of Ukraine 3741-98 “Metrology”.

We have improved the method of measuring the segments by invar wire. Dimensions have been reduced to 10 meters, a tension system has been developed, and a photo fixation technique which provides accurate counts from 20 to 40 microns has been used [Perii, 2014].

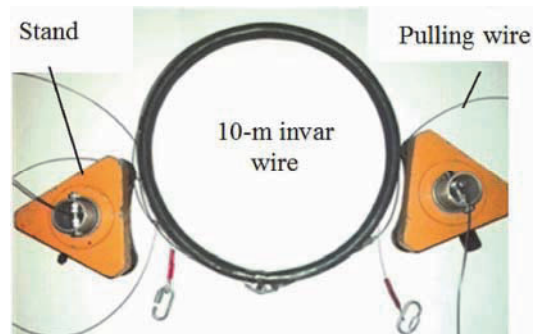

Fig. 8. Set of installation for measurement of ten-meter segments

State verification standard “VETU” 01-03-05-98 for measuring instruments of length with an accuracy of 1 μm is shown in Fig. 9.

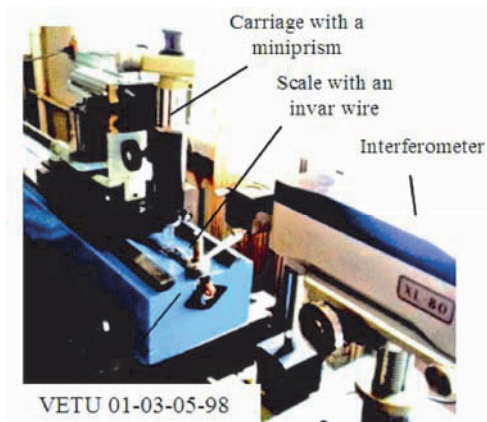

Fig. 9. Calibration of a ten-meter invar wire

The measurement scheme of the basic ten-meter segment is shown in Fig. 10. In order to maintain a stable position of tripods 1 and 2, the task of balancing the tension system arises: finding the optimal distance l from the support leg to the center and the height of the tripod – h .

In order for the tension system to be in equilibrium, it is necessary that the tripods 1 and 2, which perceive the horizontal forces caused by the tension of the invar wire and the weight of the counterweight to a 10kg weight, be in a position of stable equilibrium (Fig. 10). This balance will be ensured when all the legs of the tripod exert a clamping force.

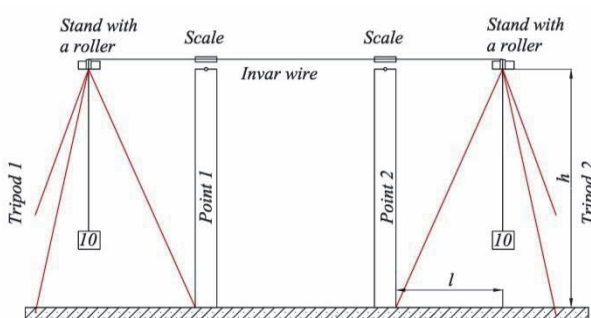

Fig. 10. Installation scheme for measuring 10-meter sections

To establish the correspondence between the active forces and the geometric parameters of the tripod, which provide the above conditions, we consider the equilibrium of the node D (Fig. 11).

Since the spatial convergent system of forces makes influence on the object of equilibrium, we write the equation of equilibrium in the form:

$$\begin{cases} \sum F_{iZ} = 0, -P + R_1 \cos \alpha + R_2 \cos \alpha + R_3 \cos \alpha = 0 \\ \sum F_{iY} = 0, -P + R_1 \sin \alpha - R_2 \sin \alpha \cos 60 - R_3 \sin \alpha \cos 60 = 0 \\ \sum F_{iX} = 0, -R_2 \sin \alpha \cos 30 + R_3 \sin \alpha \cos 30 = 0 \end{cases} \quad (8)$$

From the third equation of the system (8), we have $R_2=R_3=R$. Then, we substitute the obtained values in the first and second equations and express R and R_1 in this way:

$$R = \frac{P(\operatorname{tg} \alpha - 1)}{3 \sin \alpha}, \quad (9)$$

$$R_1 = \frac{P}{\cos \alpha} - 2R. \quad (10)$$

The analysis of the dependences (9) and (10) shows that at $\alpha < 45^\circ$ the forces of R and R_1 will be negative, and at $\alpha > 45^\circ$, they will be positive. This means that, based on the condition of equilibrium (8), at $\alpha > 45^\circ$ the tripod will be in a stable equilibrium position, and at $\alpha < 45^\circ$ – the equilibrium will be disturbed. The angle $\alpha > 45^\circ$ can only be provided under condition $l > h$ (Fig. 10).

The calculations of the tripod balance during loading according to Fig.11, can be checked, considering the balance of only the leg, which rests in the projection (point A). We record the moment of force at point A:

$$\sum M_A(\bar{F}_i) = 0, \quad (11)$$

$$-Ph + P_1l = 0. \quad (12)$$

For equilibrium it is necessary to withstand the condition:

$$P_1l \geq Ph. \quad (13)$$

Since $P_1 = P$, then the equilibrium condition will be written as:

$$l > h, \quad (14)$$

which corresponds to previous calculations.

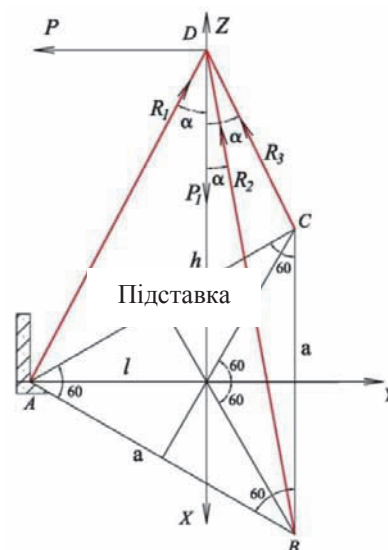

Fig. 11. Balancing of the force system of tension installation

Since geodetic tripods in the expanded state have a maximum length of 1.8 m, in order to ensure equilibrium of the system, the points of the geodetic basis should be laid at a height of not more than 1.3 m.

It is also suggested to use a three-dimensional model, where coordinates of stations and stamps are a priori known. Given the available information, it is possible to determine:

- optimal coordinates for station installation;
- accuracy of determination of the station coordinates;
- horizontal and vertical angles to ensure perpendicularity of the sight beam to the marking plane.

The technique allows to reduce the number of stations during the measurement works. For example, a quadrangular structure can be measured from two stations.

Scientific novelty and practical significance

The method of balancing forces in a geodetic tripod is the first attempt to automate the alignment of the device. Optical calculation of a triple prism can be used to determine a permanent of a geodetic device without measurements as the basis. The calculation of the optimal geodetic mark image provides unambiguous collimating and increases the accuracy of angular measurements. The method of laying the geodetic stroke with the use of a spherical reflector on the supports, which significantly compensates for the errors of centering, reduction and measurement of heights of the device/reflector, is investigated. [Lithinsky 2015, Vivat 2015, Vivat 2016].

The proposed three-dimensional model and three-dimensional mark will increase accuracy, efficiency and reduce the cost of engineering and geodetic measurements.

Conclusions

The method for determination of geometrical parameters of engineering structures in the spatial coordinate system with the help of an electronic tacheometer was researched. For this purpose, a ten-meter standard for the control of the distance measuring part was made.

The influence of the errors of angular measurements on the coordinates being determined was investigated.

A special device for linear-angular measurements was created, which allows to center special marks for measuring angles with glued reflective films for measuring lines with an accuracy of 0.05 mm.

REFERENCES

- Baran P. I. *Inzhenerna heodeziia*. Kyiv: PAT “VIPOL”, 2012, P. 618.
- Bihter Erol. Evaluation of High-Precision Sensors in Structural Monitoring. *Sensors*. 2010, DOI:10.3390/s101210803.
- Bolshakov V., Vasiutynskyi Y. Yu., Kliushyn E. B. y dr.]. *Metody y prybory vysokotochnykh heodezycheskykh yzmerenyi v stroytelstve*. Moscow: Nedra, 1976, P. 335.
- Borovy V. O., Burachek V. *Vysokotochni inzhenerno-heodezychni vymiriuvannia*. Vinnytsia: TOV “Nilan-LTD”, 2017, P. 236.
- Burak. K. *Tekhnolohiia rozplanuvalnykh robit i vykonavchykh zniman z vykorystanniam TPS* [Technology of lay-out works and executive survey using TPS]. *Geodesy, Cartography, and Aerial Photography*. 2011, issue 75, pp. 53–57.
- Chyzh I., Tymchuk H. S., Shysh T. O., Afonchyn N. B. *Aberometriia optychnoi systemy oka liudyny*. Kyiv: NTUU KPI, 2013, P. 292.
- DBN V.1.3-2:2010. *Systema zabezpechennia tochnosti heometrychnykh parametriv u budivnytstvi*. *Heodezychni roboty u budivnytstvi, Chynnyi vid 01.09.2010*. Kyiv: Minrehionbud Ukrainy, 2010, P. 49.
- DSTU-N B V.1.3-1:2009. *Vykonannia vymiriuvan, rozrakhunok ta kontrol tochnosti heometrychnykh parametriv, Chynnyi vid 01.10.2010*. Kyiv: Minrehionbud Ukrainy, 2010, P. 71.
- ISO 17123-1. Optics and optical instruments. Field procedures of testing geodetic and surveying instruments. Part 1: Teory. 2014.
- ISO 17123-5. Optics and optical instruments. Field procedures for testing geodetic and surveying instruments. Part 5: Total stations. 2018.
- Lambyn V. *Yssledovanye osobennosti yzmerenyia rasstoiany pry nabliudenyakh na plenochnye otrazhately. Suchasni dosiahnennia heodezychnoi nauky ta vyrobnytstva* [Modern achievements in geodetic science and industry]. 2011, no. 2 (22), pp. 119–123.
- Litynskyi V. O., Vivat A., Perii S., Litynskyi S. *Sposib vymiriuvannia vzhrtsevoho bazysa 2-ho rozriadu dlia etalonuvannia elektronnykh takheometriv*. *Geodesy, Cartography, and Aerial Photography*. Lviv 2015, issue 81, pp. 59–65.
- LEICA ABSOLUTE TRACKER AT960 2014. Available at: https://metrology.leica-geosystems.com/downloads123/m1/metrology/general/brochures/Leica%20AT960%20brochure_ru.pdf.
- Perii S. S. et al. *Vyznachennia intervaliv etalonnogo Berezhanskoho bazysa metodom fotofiksatsii. Naukovi visnyk Uzhhorodskoho universytetu*. issue 3. *Seriia heohrafiia i zemleustrii. Pryrodokorystuvannia*. 2014, p. 93–95.
- Romanyshyn I., Malitskyi A., Lozynskyi V. *Klasyfikatsiia ta osnovni kharakterystyky nazemnykh 3D-skaneriv. Suchasni dosiahnennia*

- heodezychnoi nauky ta vyrobnytstva* [Modern achievements in geodetic science and industry]. 2012, issue II (24), pp. 69–74.
- Rusynom M. M. *Habarytnye raschety optycheskykh system*. Moscow: HOSHEOLTEKHYZDAT, 1963, P. 397.
- Vivat. A. I., Litynskyi V., Litynskyi S. *Tochnist vyznachennia polozhennia tochok metodom obnernoi zasichky. Mizhnarodna naukova konferentsiia "Inovatsiynne technologie geodezyjne"*. Zheshuv, Poland, 10–12 June 2015.
- Vivat. A. I., Litynskyi V., Litynskyi S. *Metodyka stvorennia opornoj merezhi dlia zabezpechennia budivnytstva sporud ta sposterezhen za yikhnyimi deformatsiiami. Mizhnarodna naukovo-tekhnichna konferentsiia Heoforum. Zb. nauk. pr. Lviv, 2016.*
- Voitenko S., Shults R., Voitenko S. *Heodezychne zabezpechennia vlashtuvannia pokrivli NSK "Olimpiyskiy, Suchasni dosiahnennia heodezychnoi nauky ta vyrobnytstva* [Modern achievements in geodetic science and industry]. 2010, no. 1 (19), pp. 185–192.
- Werner Lienhart. Geotechnical monitoring using total stations and laser scanners. *J Civil Struct Health Monit*, 7, 2017, pp. 315–324, DOI 10.1007/s13349-017-0228-5.

A. ВІВАТ*, А. ЦЕРКЛЕВИЧ, О. СМІРНОВА

Кафедра інженерної геодезії, Національний університет "Львівська політехніка", вул. С. Бандери, 12, Львів, Україна, 79013, тел. +38(032)2582387, e-mail anatolii.y.vivat@lpnu.ua

ДОСЛІДЖЕННЯ ПРИЛАДІВ ДЛЯ ВИМІРЮВАННЯ ГЕОМЕТРИЧНИХ ПАРАМЕТРІВ КОНСТРУКЦІЙ ІНЖЕНЕРНИХ СПОРУД

Мета. Виконати дослідження можливостей електронних тахеометрів щодо контролю ними геометричних параметрів інженерних конструкцій. **Методика.** Проаналізовано нормативну літературу на виконання геодезичних робіт у промисловому виробництві та будівництві. Досліджено методи та прилади, які застосовують для цього. **Результати.** Запропоновано використовувати для таких задач електронний тахеометр та спеціальну методика. Для цього проведено дослідження віддалеміра електронного тахеометра. Для контролю виміру віддалей безпосередньо на будівельному майданчику розроблено установку з десятиметрового інварного дроту, яку попередньо повірено на еталоні 1-го розряду у науково дослідному інституті метрології з точністю, що не перевищувала 0,01 мм. Розроблено методика передачі еталонної віддалі, в якій використано спеціальні сфери та геодезичні пункти закріплені отвором. Для прямих вимірів відрізків досліджено методика натягу інварного дроту, а також виконано механічне врівноваження гирьової системи. Контроль куткових величин приладу здійснено на метрологічній установці вищого порядку. Встановлено вплив неперпендикулярності осей та ексцентриситету на точність виміру кутів. Для оптимізації наведення на світловідбивну марку проведено дослідження рисунка марки та спеціального кронштейна, що дало можливість з точністю в межах 10° зорієнтувати марку перпендикулярно до світлового променя електронного тахеометра. Також досліджено трипеліпризму і встановлено залежність між висотою, діаметром та центром відбиття. Розроблено конструкцію сферичного відбивача та підставки для прокладання ходів з компенсацією похибок центрування, редукції та виміру висот для приладу і відбивача. Розроблено конструкцію кронштейна (вектора) з двома відбивачами для виконання обмірних робіт. Розроблено тримірну модель промислового об'єкта для оптимального планування місць для закріплення геодезичної основи та перехідних точок для встановлення електронного тахеометра. **Наукова новизна** Метод врівноваження сил у геодезичному штативі можна розглядати як основу для започаткування автоматизації центрування приладу. Оптичний розрахунок трипеліпризми можна застосувати для визначення постійної поправки геодезичного приладу без вимірів на базисі. Розрахунок оптимального зображення геодезичної марки забезпечує однозначність візування та підвищує точність куткових вимірювань. **Практична значущість.** Користуючись розробленою методикою, можна будь-яким електронним тахеометром визначити просторові координати інженерної конструкції з контролем вимірів та оптимальною їхньою точністю.

Ключові слова: технічні і високоточні вимірювання, еталонний лінійний базис, дослідження електронних тахеометрів, приладова поправка, лінійно-кутові виміри, оптимізація геодезичних вимірювань.

Received 07.03.2018