

S.S. HERASHCHENKO, V.A. MAKHLAJ, N.N. AKSENOV, I.E. GARKUSHA,  
O.V. BYRKA, N.V. KULIK, V.V. CHEBOTAREV, V.V. STALTSOV

Institute of Plasma Physics, NSC KIPT

(1, Akademichna Str., Kharkiv 61108, Ukraine; e-mail: gerashchenko@kipt.kharkov.ua)

## EROSION OF THE COMBINED THREE-DIMENSIONAL TUNGSTEN TARGET UNDER THE IMPACTS OF QSPA Kh-50 POWERFUL PLASMA STREAMS

UDC 533.924

---

*For the first time, the features of the interaction of plasma with materials and the erosion mechanisms have been evaluated for surfaces in a three-dimensional geometry exposed by powerful plasma. Experimental studies of the powerful interaction of plasma with the three-dimensional structures have been carried out on a quasistationary plasma accelerator QSPA Kh-50. The plasma streams with surface heat loads of  $0.9 \text{ MJ/m}^2$  and plasma pulse duration  $0.25 \text{ ms}$ , relevant to ITER ELM, have been used in the experiments. The significant erosion occurs under the action of plasma heat loads. Erosion is accompanied by the separation of material particles from the irradiated surfaces. It is found that the number and the velocity of particles emitted from the surface depend on the number of plasma pulses. The most significant factors causing a macroscopic erosion for a three-dimensional tungsten structure have been studied.*

*Keywords:* divertor, castellated structure, quasistationary plasma accelerator, plasma-surface interaction.

### 1. Introduction

Divertor plates in a fusion reactor ITER will be constructed in a three-dimensional geometry, the so-called castellated structures, for which the tungsten is selected as the main armoring material [1]. Tungsten has a high energy threshold for the physical sputtering, high melting point, and high thermal conductivity. It is also characterized by low tritium retention [2, 3]. However, tungsten has a high ductile-to-brittle transition temperature, resulting in the cracking under repetitive thermal loads during transient events in the ITER such as disruptions and ELMs (Edge Localized Modes). During the operation of the reactor, the castellated structures can reduce the influence

of the induced surface currents. Another advantage of such structures is a reduction in thermal stresses, which lead to the formation of macro- and microcrack networks on the surface of tungsten. This is one of the significant mechanisms of erosion of a tungsten armor [4, 14]. The formation of a melted layer with the following droplet splashing erosion causes the essential damages of the divertor during transient events. Numerical and experimental simulations of the behavior of castellated structures under conditions relevant to the ITER transient events have shown that the processes on the unit structure edges result in the special contribution to the erosion. The development of instabilities on the edges (Rayleigh–Taylor instability, Taylor criterion) leads to the particle ejection into the plasma volume. The “bridges” are formed through the gaps between the structure units, and they may be also separated from the structure under the further plasma impacts [5, 6]. The

---

© S.S. HERASHCHENKO, V.A. MAKHLAJ,  
N.N. AKSENOV, I.E. GARKUSHA, O.V. BYRKA,  
N.V. KULIK, V.V. CHEBOTAREV,  
V.V. STALTSOV, 2016

quasistationary plasma accelerators (QSPA) can reproduce the required parameters of a plasma load such as the pulse duration and the energy density in the experimental simulations of ITER transient events. Thus, the QSPA enables to investigate the behavior of structural elements of the reactor under the impacts of plasma with required parameters and irradiation doses [7]. Some aspects of the castellated structure behavior under thermal loads, which lead to the melting of a material have been investigated previously [8, 9]. However, the evaluation of the influence of edge effects on the mechanism of erosion of the tungsten castellated structure still requires a further experimental study. This paper presents the series of experiments on the study of the interaction of repetitive powerful plasma streams of QSPA Kh-50 with a three-dimensional tungsten structure under conditions relevant to the ITER transient events.

## 2. Experimental Setup and Diagnostics

The experimental study of erosion of a three-dimensional structure has been carried out on a powerful quasi-stationary plasma accelerator QSPA Kh-50 – the largest and most powerful device of this kind [7, 10]. The main parameters of hydrogen plasma streams are as follows: ion impact energy is about (0.4...0.6) keV, the maximum plasma pressure is up to 0.32 MPa, and the stream diameter of 18 cm. The plasma pulse shape is approximately triangular, and the pulse duration of 0.25 ms. The energy density of the plasma stream is in the range of – (0.5...30) MJ/m<sup>2</sup>. The energy density in a free plasma stream and the surface heat load were measured by local calorimeters. The plasma pressure was measured by piezoelectric detectors. The observation of erosion products during the interaction of repetitive plasma pulses with the tungsten structure was performed with a high-speed 10-bit CMOS pco.1200 s digital camera PCO AG (exposure time from 1 μs to 1 s, spectral range from 290 to 1100 nm). The registration and the analysis of erosion products were made by a scheme, which was used in the earlier experiments on QSPA Kh-50 [11].

The target design is a collection of nine tungsten cylinders fixed in polyamide. The diameter of each cylinder is 5 mm, height – 20 mm, and minimal gap between the cylinders – 1 mm. The ceramic plate was placed behind the target for collecting the erosion products (Fig. 1).

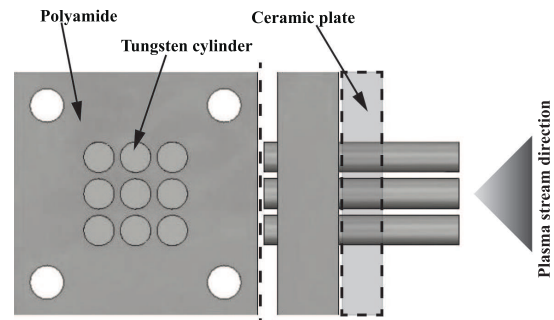

Fig. 1. Scheme of a three-dimensional target

The three-dimensional tungsten target was irradiated by plasma streams with a surface heat load of 0.9 MJ/m<sup>2</sup> (between the melting and evaporation thresholds of tungsten defined earlier) [10]. The surface of the target was placed perpendicularly to the plasma stream direction. The target temperature before and between irradiating pulses was slightly differed from room temperature. The maximum number of plasma impacts – 100 pulses. The analysis of the exposed target surfaces and particles collected on the ceramics was carried out with an optical microscope MMR-4 equipped with a CCD camera.

## 3. Experimental Results

The molten layer is formed on the target irradiated by plasma with the above-mentioned surface heat load [7, 10]. The melt moves under the action of external forces, first of all, the pressure gradient and the temperature gradient [12]. The plasma-surface interaction is accompanied by the intense droplet/dust ejection from the exposed surfaces. After the first irradiating pulse, the local overheating of the target edges and the particle ejection are observed (Fig. 2). Particles are ejected from the target surface, as well as from the target volume. It is found that the separation of particles from the target depends on the number of impacting plasma pulses and has threshold character (Fig. 3). At the initial irradiation dose up to 5 pulses, the particles are emitted during each pulse. A lot of particles is emitted from the target during 20–31 pulses, but with a larger interval of 5–6 plasma pulses. The next local maximum of the emission of particles occurs after 61–62 pulses, probably, due to the development of mountains of a displaced material at the target edges. A small number of ejected par-

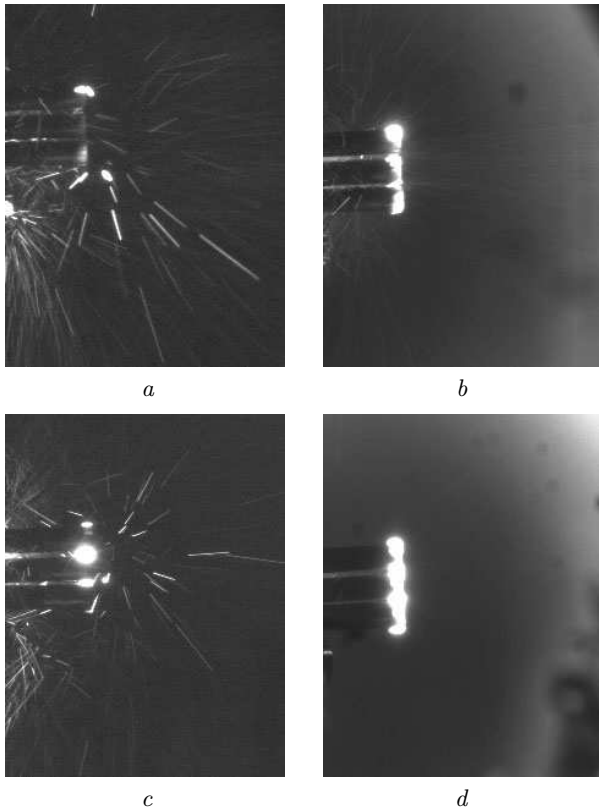

Fig. 2. Frames of the digital camera after 20 (a), 30 (b), 61 (c), and 100 (d) plasma pulses. The exposure time – 1.2 ms

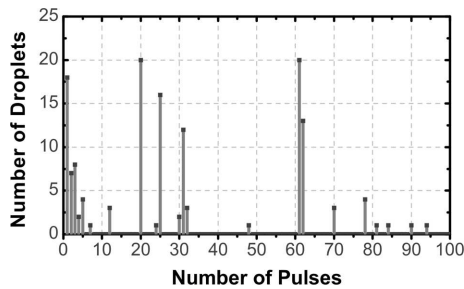

Fig. 3. Number of ejected particles vs. the number of plasma pulses

particles are observed on the frames of a digital camera with next exposed pulses and till the end of a plasma irradiation series.

The distributions of velocities and the number of ejected particles depending on the time of a start from the target were obtained on the basis of an exposure time of the frame and the particle track length. The particles with the large values of velocity correspond

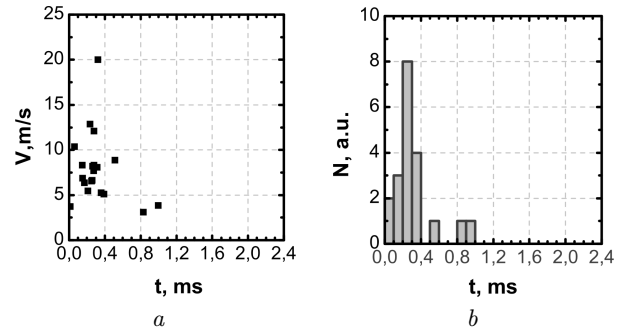

Fig. 4. Distributions of velocities (a) and numbers (b) of ejected particles vs. the start-up time from the exposed surface after the 20-th plasma pulse

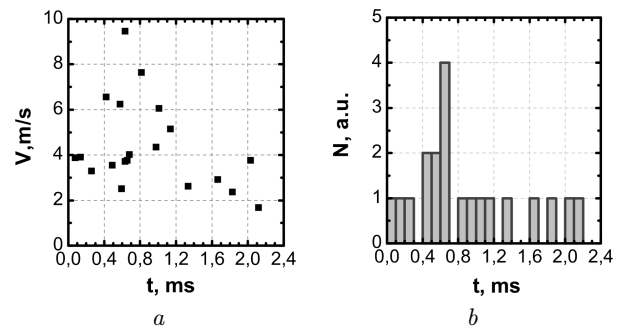
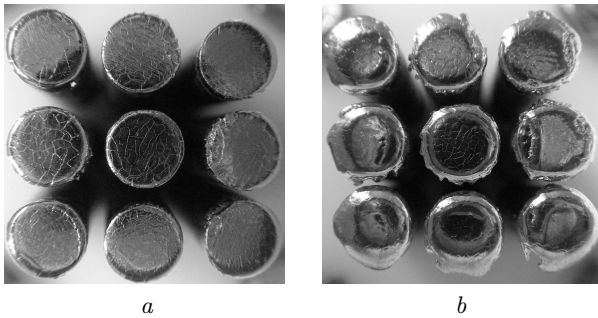

Fig. 5. Distributions of velocities (a) and the number (b) of ejected particles vs. the start-up time from the exposed surface after the 61-st plasma pulse

to the longer tracks with lower glow intensity on the frames. The analysis of camera frames after 20 pulses has shown that most particles start from the surface in the time range of (0... 0.4) ms (0 – the beginning of the plasma-target interaction), and the maximum velocity is up to 20 m/s (Fig. 4). As the irradiation dose increases up to 60 plasma pulses, most particles start from the surface in the time range of (0.4... 0.7) ms, the maximum velocity being up to 10 m/s (Fig. 5).

As was been shown early, the melt exists on the surface up to 0.25 ms. After this, it is solidified [12]. Thus, at the irradiation dose less than 20 pulses, most of the emitted particles are in the liquid state and have velocities up to 15 m/s. After the 61-st pulse, the majority of emitted particles are in the solid state with velocities up to 10 m/s. The velocity of liquid particles reduces to 4 m/s probably due to an increase in the size of such particles.

The analysis of the exposed target surfaces showed the development of crack networks on the surface



**Fig. 6.** General view of the exposed target surfaces after 10 (a) and 100 (b) plasma pulses

and the melt motion (Fig. 6). The macrocrack network with average cell size up to  $500 \mu\text{m}$  is formed on the exposed surface after first several plasma pulses (Fig. 6, a). Such kind of cracks appears due to the ductile-to-brittle transition effect, and it may result in the ejection of a solid dust from the exposed surfaces. The macrocrack width is about  $6 \mu\text{m}$ . The microcracks with a cell size about  $50 \mu\text{m}$  are observed against the background of macrocracks due to the resolidification of the melted layer (Fig. 7). The width of such cracks does not exceed  $1 \mu\text{m}$ .

The roughness of the exposed surfaces increases with the number of the irradiating plasma pulses. It is caused by growing the width and a swelling of the edges of cracks, as well as the melt motion and the development of instabilities in the melted layer. Nevertheless, the macrocracks are partially filled by the molten material (Fig. 6, b). The most overheated cylinder edges are smoothed out after several first plasma impacts. Further, the melt motion and its solidification lead to the appearance of pronounced protuberances on the edges of the cylinders, so-called “umbrellas”. The “umbrellas” are not uniform due to the development of instabilities on the edges of the cylinders. In particular, on some units, the “umbrellas” become longer. They may cover the gaps between the elements of the three-dimensional structure. As a result, the “bridges” appear between the elements of the structure, as was shown earlier [6, 8]. The “umbrellas” may be destroyed under the action of further irradiating plasma pulses. Therefore, they can be a source of emitted particles (Fig. 6, b). Thus, it is shown that the development of cracks and the melt motion on the exposed surfaces lead to an essential modification of the target surface.

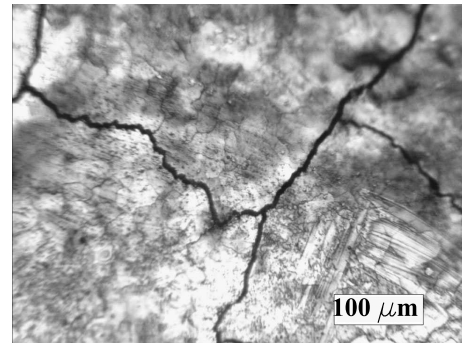

**Fig. 7.** Networks of macro- and microcracks on the exposed surface of the three-dimensional target

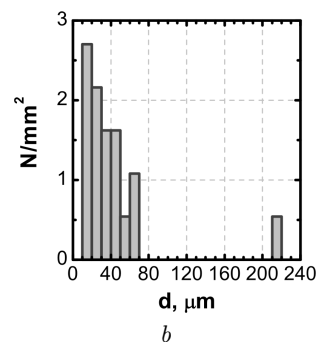
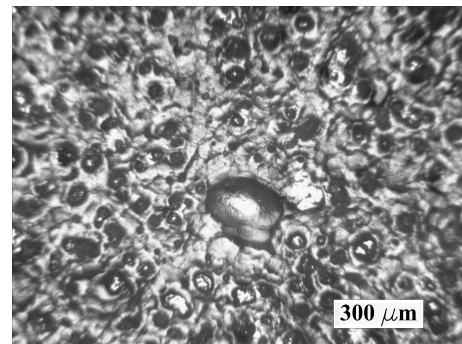

**Fig. 8.** View of the surface area of the collected plate (a) and the distribution of particles re-deposited on the collected plate vs. the particle size (b)

The analysis of the surfaces around the cylinder structure and the collecting plate (Fig. 1) shows the presence of re-deposited particles from the structure. The surface analysis of the collecting ceramic plate showed that the maximum size of collected particles exceeds  $200 \mu\text{m}$  (Fig. 8). Most of the collected particles have sizes in the interval  $(10 \dots 70) \mu\text{m}$  (Fig. 8, b).

The erosion of flat tungsten targets was investigated during earlier experiments on the QSPA Kh-50 in detail. The erosion of both flat and three-dimensional targets is characterized by the cracking of surfaces irradiated by plasma with similar parameters. It should be noted that the crack networks on the surfaces of flat and three-dimensional targets have similar typical sizes [13]. At same time, some cracks are partially filled by a melt under the sequential plasma irradiation [14]. For both target types, the development of instabilities is observed in the melted layer during its motion along the exposed surface. The Kelvin–Helmholtz instability is dominated in the erosion of flat targets. The Kelvin–Helmholtz and Rayleigh–Taylor instabilities develop on the three-dimensional target. The Rayleigh–Taylor instability and the Taylor criterion breach are predominant factors, which influence the development of a surface relief due to the presence of sharp edges in the target. In general, the damages of tungsten targets due to the cracking and the development of instabilities at the surface layer lead to the particle ejection from the exposed surfaces. Earlier, it was found experimentally that the sizes of particles re-deposited on surfaces around the target are in range of (1 ... 60)  $\mu\text{m}$  [15]. In the current experiment, as was mentioned above, most of the particles have sizes in the interval (10 ... 70)  $\mu\text{m}$ . But the particles with size more than 200  $\mu\text{m}$  are observed as well. This can be explained by effects on the edges of three-dimensional construction units (in particular, formation and destruction of “umbrellas” and “bridges”) (Figs. 3 and 8).

#### 4. Conclusions

The features of the interaction of plasma with tungsten targets of three-dimensional geometry have been studied under repetitive plasma loads with parameters relevant to ITER ELM (surface heat load of 0.9 MJ/m<sup>2</sup> and pulse duration of 0.25 ms).

It has been shown that the plasma heat loads lead to a significant erosion of the target, which is accompanied by the separation of tungsten droplets/dust from the target surface. The number and velocities of ejected particles depend on the number of irradiating plasma pulses: as the number of pulses increases, the velocities of particles decrease, whereas the start-up time increases. The formation of cracks and the melt motion modify the surface and edges

of the irradiated construction depending on the number of plasma pulses. These processes determine the number and properties of particles ejected from the tungsten target.

*This work has been performed in the frame of the program of the NAS of Ukraine “Prospective studies on plasma physics, controlled thermonuclear fusion, and plasma technology”, project II-5/24-2015, and was partially supported by the STCU project 6057.*

1. T. Hirai *et al.*, Phys. Scr. **159**, 014006 (2014).
2. T. Hirai *et al.*, J. of Nucl. Mater. **463**, 1248 (2015).
3. M. Rieth *et al.*, J. of Nucl. Mater. **442**, S173 (2013).
4. V.A. Makhraj *et al.*, Phys. Scr. **138**, 01460 (2009).
5. B. Bazylev *et al.*, J. of Nucl. Mater. **390–391**, 810 (2009).
6. A. Zhitlukhin *et al.*, J. of Nucl. Mater. **363–365**, 301 (2007).
7. V.I. Tereshin *et al.*, Plasma Phys. and Controlled Fusion **49**, No. 5, A231 (2007).
8. V.A. Makhraj *et al.*, J. of Nucl. Mater. **463**, 210 (2015).
9. S.S. Herashchenko *et al.*, Problems of Atomic Science and Technology **6**, 44 (2014).
10. I.E. Garkusha *et al.*, Phys. Scr. **138**, 014054 (2009).
11. V.A. Makhraj *et al.*, Acta Polytech. **53**(2), 193 (2013).
12. I.E. Garkusha *et al.*, Fusion Science and Techn. **65**, 186 (2014).
13. I.E. Garkusha *et al.*, J. of Nucl. Mater. **415**, 65 (2011).
14. I.E. Garkusha *et al.*, J. of Nucl. Mater. **337–339**, 707 (2005).
15. V.A. Makhraj *et al.*, Phys. Scr. **159**, 014024 (2014).

Received 20.11.15

*C.C. Герашченко, В.О. Махлай,  
М.М. Аксенов, І.Є. Гаркуша, О.В. Бирка,  
М.В. Кулик, В.В. Чеботарьов, В.В. Стальцов*

ЕРОЗІЯ СКЛАДЕНОЇ ТРИВИМІРНОЇ  
ВОЛЬФРАМОВОЇ МІШЕНІ ПІД ВПЛИВОМ  
ПОТУЖНИХ ПЛАЗМОВИХ ПОТОКІВ З КСПП Х-50

#### Резюме

Вперше досліджені особливості взаємодії плазми з матеріалами та механізми ерозії в тривимірній геометрії поверхні, під впливом потужного плазмового опромінення. Експериментальні дослідження взаємодії потужної плазми з тривимірними структурами виконані на квазістаціонарному плазмовому прискорювачі КСПП Х-50. В експериментах застосовували потоки плазми з тепловим навантаженням на поверхню – 0,9 МДж/м<sup>2</sup> та тривалістю плазмового імпульсу – 0,25 мс, що є близькими до умов ITER ELM. Під впливом зазначених теплових навантажень відбувається суттєва ерозія мішені, що супроводжується відокремленням часток матеріалу від опромінованих поверхонь. Встановлено, що кількість та швидкість часточок, які відлітають з поверхні, залежить від кількості імпульсів. Досліджені найбільш значущі джерела макроскопічної ерозії вольфрамової тривимірної конструкції.