

PACS: 89.30.Gg, 28.41.Qb, 81.65.Tx

THE INVESTIGATION OF Zr-Ni NON-EVAPORABLE GETTER PROPERTIES**S.D. Lavrinenko, M.M. Pylypenko, H.M. Aksonova, A.P. Svinarenko,
Yu.P. Bobrov, I.V. Kolodiy***National Science Center «Kharkiv Institute of Physics and Technology»,
1, Akademicheskaya Str., Kharkov 61108, Ukraine**E-mail: aksonova_anya@mail.ru*

Received September 26, 2015

The investigation results for the non-evaporable getter with the chemical composition Zr (60) – Ni (40 wt.%), that was prepared by calciumthermic technology and comprised two phases: ZrNi and Zr₂Ni are presented. The phase composition, microstructure and gas release spectrum from the alloy sample are investigated. It has been concluded that the tested material can be used as a getter component for hydrogen “traps” creation in the NPP's constructional materials and welds.

KEY WORDS: non-evaporable getter, alloy, phase composition, microstructure, gas emission**ДОСЛІДЖЕННЯ ВЛАСТИВОСТЕЙ ГЕТЕРА, ЩО НЕВИПАРОВУЄТЬСЯ, НА ОСНОВІ СПЛАВУ СИСТЕМИ Zr-Ni****С.Д. Лавриненко, М.М. Пилипенко, Г.М. Аксьонова, А.П. Сви́наренко, Ю.П. Бобров, І.В. Колодій***Національний науковий центр «Харківський фізико-технічний інститут»**вул. Академічна 1, м. Харків 61108, Україна*

Наведено результати дослідження гетерного матеріалу, хімічного складу Zr (60) – Ni (40 мас.%), який отримано по кальцістермічній технології, і який містить фази: ZrNi і Zr₂Ni. Досліджено фазовий склад, мікроструктуру та спектр газовиділення із зразка сплаву. Зроблено висновок, що цей матеріал може розглядатися в якості гетерного додатку для створення “пасток” водню в конструкційних матеріалах та зварних з'єднаннях устаткування АЕС.

КЛЮЧОВІ СЛОВА: гетер, що не випаровується, сплав, фазовий склад, мікроструктура, газовиділення**ИССЛЕДОВАНИЕ СВОЙСТВ НЕРАСПЫЛЯЕМОГО ГЕТТЕРА НА ОСНОВЕ СПЛАВА СИСТЕМЫ Zr-Ni****С.Д. Лавриненко, Н.Н. Пилипенко, А.Н. Аксенова, А.П. Сви́наренко, Ю.П. Бобров, И.В. Колодий***Национальный научный центр «Харьковский физико-технический институт»**ул. Академическая 1, г. Харьков 61108, Украина*

В работе представлены результаты исследований геттерного материала, имеющего химический состав Zr (60) - Ni (40 мас.%), полученного по кальциетермической технологии и содержащего фазы: Zr₂Ni и ZrNi. Исследованы фазовый состав, микроструктура и газовыделение из образцов сплава. Сделан вывод, что этот материал может рассматриваться в качестве геттерной добавки при создании “ловушек” водорода в материалах и сварных соединениях конструкций АЭС.

КЛЮЧЕВЫЕ СЛОВА: нераспыляемый геттер, сплав, фазовый состав, микроструктура, газовыделение

Improvement in quality of structural materials in construction of nuclear power stations (NPPs) is the most important direction for the development of the nowadays material sciences.

Very tight specifications impose to quality of welds that in used structural materials broadly determine their reliability and durability.

It has been established that, strength characteristics loss of welds depends significantly on hydrogen that contained in weld zone and round about it. Hydrogen is a detrimental impurity because it deteriorates many characteristics of welds. It causes to the embrittlement and the uncontrolled stabilization that hinders inelastic deformation under mechanical metal-working of structural materials. It also adversely affects on long-term stress and thermal stability; static and thermal fatigue, endurance, endurance strength and also, adversely affects on creep flow characteristics.

One of the ways to decrease this negative hydrogen influence is bonding it in hydrogen “traps” which can be non-evaporable getters, added in weld zone and round about it. Such “traps” blocks up hydrogen diffusion, absorb, collect and hold down it effectively [1].

In the present paper as the hydrogen “trap” the alloy Zr (60) – Ni (40 wt.%), comprised two phases: ZrNi and Zr₂Ni, is provided. According to the earlier studies [2] ZrNi and Zr₂Ni intermetallic compounds can absorb ~ 2 wt.% hydrogen under ambient temperature and atmospheric pressure. In spite of hydrogen ZrNi absorbs extensively CO, O₂, H₂O. Intermetallide Zr₂Ni absorbs extensively O₂, H₂O. These intermetallics also activate easy start with ~ 250 °C, under 900 °C they activate during less than 1 min.

The elements of this alloy (Zr, Ni) have nuclear characteristics that correspond for nuclear chain reactor under working conditions [3].

These alloys technology is well proven; they can be getting in right amounts. The alloys are crushed in grits or powder in required dimensions. It is essential when the technologic adding them in weld zone and round about it and also another construction material is developing.

The experiments in cooperation of hydrogen with the NPS construction materials, including studying of process gas release spectrum from materials, can be use as an powerful method of materials nondestructive testing because make it possible to determine of flow density, their changing under various impacts, output performances, demensions, capacity, hydrogen occupation density. It can be effective contribution in materials quality improvement that developing for consruction materials using in NPS building.

This present work aims at investigation the phase composition, microstructure and gas release spectrum from the alloy sample whith the chemical composition Zr (60) – Ni (40 wt.%), that was prepared by calciumthermic technology.

ALLOY TECHNOLOGY AND EXPEREMENTAL SETUP

The examination alloy was prepared by calciumthermic technology [4]. This technology has simply design, energy-efficiency and provides high quality of alloys. For alloying chemical reactions are used:



If is used nickel tetrafluoride, then



For present research the alloy was obtained by reaction (1).

The ingots of alloy are chemically homogeneous. The Ni content in the top and bootom parts can be different by less than 3.5 wt.%.

The investigation of sorption characteristic

The investigation of hydrogen and other gas impurities sorption characteristics from tested alloy under heated in the vacuum was examined on the setup that is shown in fig.1. The setup involves the vacuum chamber (1) that consists of two parts, connected together by the vacuum seal (2). The tested sample (3) is desposed on the top, which falls under experiment in the bottom of the heater (4) of the furnace (5). The temperature in the furnace (5) is measured of Pt-Pt/Rd thermocouple (6) that connected to the isothermal temperature regulator (7). Pumpdown in the chamber (1) is provided by the MX 7203 mass-spectrometer vacuum system through the nipple (8).

The investigation of sorption characteristic was hold within the temperature range from room to ~ 730 °C in the first-ever experiment and to a maximum of ~ 900 °C in the next experiment.

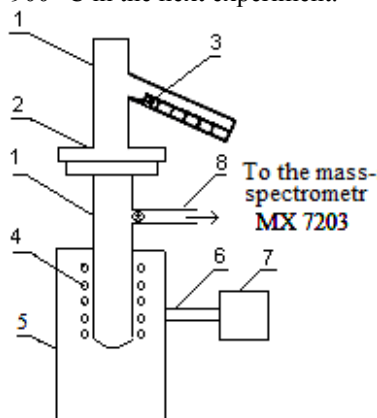

Fig.1. Schematic of setup for sorption characteristics measurement:

1 - chamber, 2 - vacuum seal, 3 – tested sample, 4 – heater, 5 – furnace, 6 – Pt-Pt/Rd thermocouple, 7 – isothermal temperature regulator, 8 – nipple

X-ray diffraction analysis

The x-ray diffraction analysis of sample alloys were taken on DRON-4-07 with copper radiation. Registered profiles of the x-ray diffraction curves are digitize and printed on the computer screen. For the indexing of x-ray photographs the PCPDF database [5] and the software applications for the x-ray structure analysis of the polycrystals are used [6].

Metallographic analysis

Metallographic analyses were performed by optical microscopy MMR-4. The surfaces of the samples before research were prepared by polishing on the abrasive papers then sanding on the diamond pastes with decrease grit size. For alloy microstructure developing the chemical etching was made with nitrogen acid, fluoric acid and hydrogen peroxide mixture. The most tailored composition was: nitrogen acid – 37.5 ml; fluoric acid – 25 ml; hydrogen peroxide – 37.5 ml. Time etching – 2 s.

RESEARCH RESULTS AND DISCUSSION

Fig. 2 shows the sections of the samples before chemical etching, which were cut out from different parts of the alloy in the longitudinal section and cross-cut of the surface. It is impressive to see pores that have a right round figure

overall and show distinct limits (dark spots on the polished section). Openness in the alloy that proposed as hydrogen sorbent it is advantage because increases active surface of the sorbent and give absorbed gas plumb into bulk quickly.

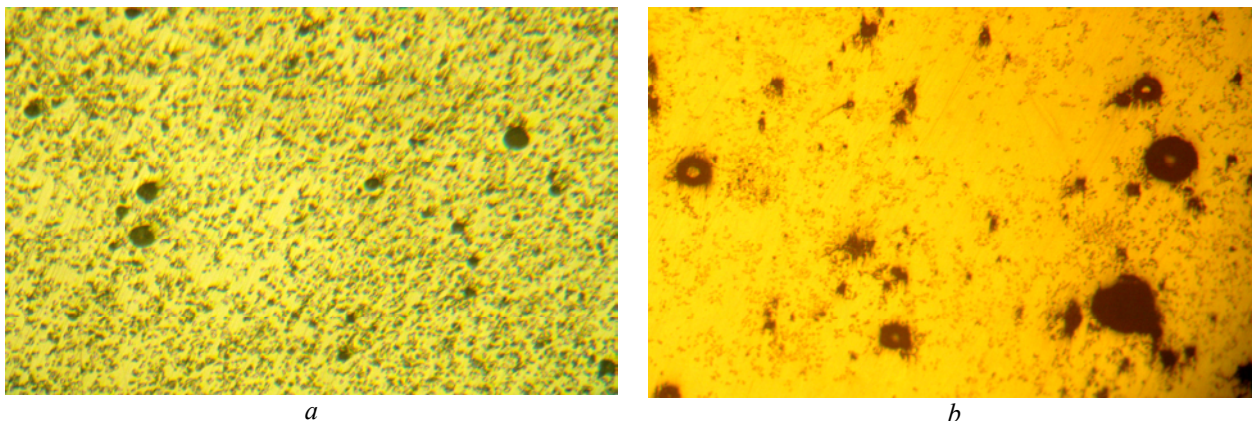

Fig. 2. The sections of the samples before chemical etching which were cut out from different parts of the alloy: *a* longitudinal section of the surface, *b* cross-cut of the surface. Magnification $\times 80$

Fig. 3,4 show the longitudinal and cross-cut of sections of the surface sample after chemical etching in nonpolarized and polarized light.

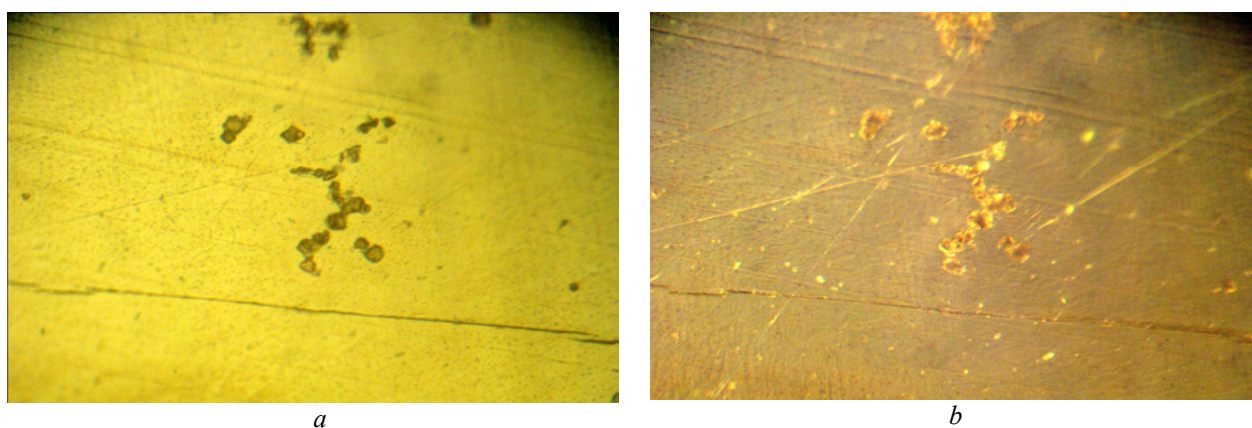

Fig. 3. Longitudinal section of the surface sample after chemical etching: *a* - nonpolarized light; *b* - polarized light. Magnification $\times 300$

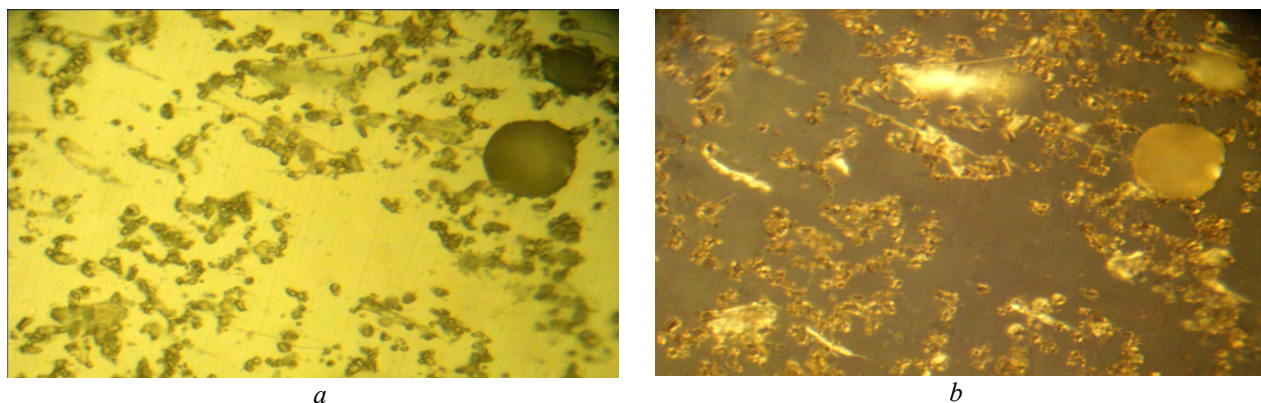

Fig 4 Cross-cut of the surface sample after chemical etching: *a* - nonpolarized light; *b* - polarized light. Magnification $\times 300$

On the longitudinal and cross-cut sections of the samples after their chemical etching are clearly seen two phases that are different own abundance ratio. Quantitative evaluations of presented phases that were examined visually show the values $\sim 80\%$ for the phase that submit on the cross-sections of the surface, as a big light area and the small precipitations of the same color, $\sim 10\%$ for the phase that submit as the small precipitations dark color. This proportion agrees with Zr_2Ni and $ZrNi$ phase proportion which was calculated from view of the Zr-Ni phase diagram according to

the segments rule. Thus we can interpret this phases as Zr_2Ni and $ZrNi$.

Metallographic analyses are used in polarized light showed that observed phases can't be related to the cubic system.

The x-ray data also showed presence two phases. Fig. 5 shows diffraction pattern of the examination alloy.

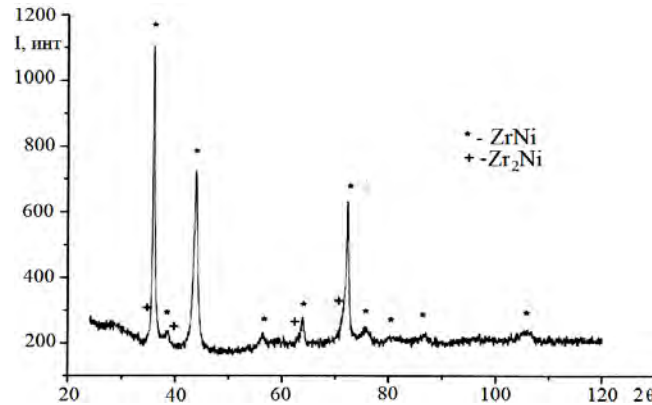

Fig. 5. The diffraction pattern of the Zr-Ni alloy under examination

One phase is indexing in orthorhombic system with the lattice parameters: $a = 3.257 \text{ \AA}$; $b = 9.944 \text{ \AA}$; $c = 4.118 \text{ \AA}$; another one is indexing in tetragonal system with the lattice parameters: $a = 6.483 \text{ \AA}$; $c = 5.267 \text{ \AA}$. These dates in good agreement with PCPDF databases for Zr_2Ni and $ZrNi$ intermetallic compounds.

Fig. 6 shows the gas release spectrum from the examination alloy which was held for a month in contact with atmosphere only, underwent neither addition annealing nor hydrogenation. Observable peaks on the desorption curve on the initial part of it up to $\sim 140 \text{ }^\circ\text{C}$ are associated with gas release of easily volatile compounds of the carbon and hydrogen (C_nH_m) which contained in passive surface of the alloy. The sulfur and its oxides that also can be at the surface of getters based on Zr weren't specified because the mass-spectrometer which is used in present work could register gases with the mass number only up to 60 [7]. The gas release spectrum in the temperature interval from $\sim 190 - 240 \text{ }^\circ\text{C}$ with the maximum under $\sim 210 \text{ }^\circ\text{C}$ is typical for the hydrogen release from Zr_2Ni intermetallic compound. The low-level spike amplitude depends on small equilibrium hydrogen pressure, which is equal to $\sim 10^{-6} \text{ Pa}$ under the referred temperature [8].

Significant gas release appears in the temperature interval from $\sim 370 - 710 \text{ }^\circ\text{C}$. Sharp peaks in this temperature interval can be associated with water release under $\sim 400 - 450 \text{ }^\circ\text{C}$ and hydrogen release under $\sim 450 - 710 \text{ }^\circ\text{C}$ mainly from $ZrNi$ and by a negligible margin from Zr_2Ni intermetallic compounds. The first peak of hydrogen release with a maximum under $\sim 480 \text{ }^\circ\text{C}$ is defined as being it release from the surface of $ZrNi$ intermetallic compound, the second peak appearance with a maximum under $\sim 570 \text{ }^\circ\text{C}$ is interpreted as hydrogen release from the bulk $ZrNi$ intermetallic compound. Desorption curve also shows small amount of hydrogen which is confined in the alloy under temperature above $\sim 700 \text{ }^\circ\text{C}$.

Fig 7. shows the gas release spectrum from the examination alloy which was anneald additionally under $926 \text{ }^\circ\text{C}$ during 1 min. and pressure was $\sim 2 \cdot 10^{-3} \text{ Pa}$. Selected annealing cycle provides full surface activation of the non-evaporable getter [9].

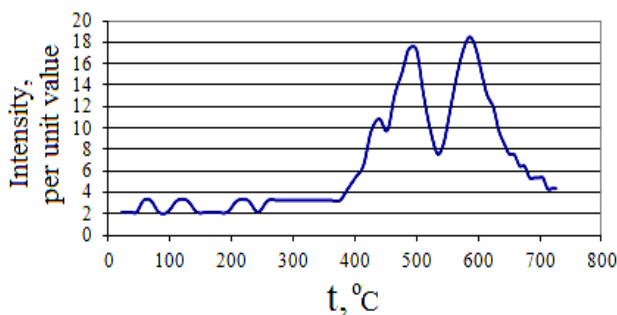

Fig. 6. The gas release spectrum from the Zr-Ni alloy before annealing

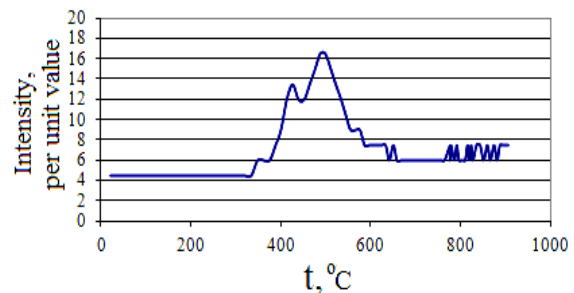

Fig. 7. The gas release spectrum from the Zr-Ni alloy after annealing

Gas release curve begin with temperature $\sim 350 \text{ }^\circ\text{C}$ and up to $\sim 900 \text{ }^\circ\text{C}$ similar in curve configuration that was presented in Fig.6. Secondary maximum of hydrogen release under temperature $\sim 576 \text{ }^\circ\text{C}$ is much less by a magnitude in comparisson with similar maximum in Fig. 6. This is due to on the one hand in the interior of the annealed sample in the bulk of it the quantity of residual hydrogen is much less then in the non - annealed sample. On the other hand this decrease of peak, uprise and location of it in general case depend on hydrogen bond energy in the intermetallid and

hydrogen diffusion rate in the bulk of alloy. Even though the least hydrogen quantity in the bulk sample during heating gets inside of bulk intermetallide (ZrNi) and after raise of temperature wherein bonds desintegration with intermetallide happen it sets up second thermodesorption peak. This fact has been described in details previously [10].

Curved line in the temperature interval from ~ 770 °C and above ~ 900 °C where is seen intensive release of hydrogen corresponds with predict curved line in the context of phenomeno-logical theory of hydrogen diffusoin in defective environments and has been confirmed in many experimental works [11, 12]. Irregular curve shape on this temperature interval firstly may be due to hydrogen which risede in various kind positions in ZrNi lattice split a bonds whith it, secondly hydrogen can be in lattice positions whith differing degrees of defect structure.

Irregular shapes of gas release curves, presented in Fig. 6,7 are typical not only for selected getter. Bimodal mode of curves was predicted by hydrogen diffusion theory in defective mediums [13]. Similar curve shapes were found experimentally and on other materials [14].

Examination alloy ability holds on small amount of hydrogen under temperature above ~ 700 °C is essential for the getter which is proposed as hydrogen “traps”.

CONCLUSIONS

The phase composition, microstructure and gas release spectrum up to temperature above ~ 900 °C from the sample of the alloy Zr(60) – Ni (40 wt.%) which prepared by calciumthermic technology were investigated. This alloy can contain small hydrogen amounts up to temperature above ~ 900 °C, thus it may be regarded as a getter component for hydrogen “traps” creation in the NPP's constructional materials and welds for their performance characteristics improvement by decrease hydrogen detrimental effect. For the purposes of possibility this getter as hydrogen “traps” it is necessary to develop the injection procedure of this hydrogen “traps” in the welds and field around it for the NPP's constructional materials.

REFERENCES

1. Pokhodnya I.K., Yavdoshin I.R., Paltsevich A.P. et al. Metallurgy of arc welding. The interaction of metal with gases. – Kiev: Naukova Dumka, 2004. - 506 p.
2. Sokolenko V.I., Tikhonovsky M.A., Volchok O.Y., Sibiliva R.M., Grigorova T.K., Gorbatenko V.M., Svinarenko A.P. et al. Development of technology for recycling sewage sludge to obtain hydrogen as fuel. Project Report No. 4960, 2011. - 27 p.
3. Beckman I.N. The nuclear industry. Lecture course. – Moscow, 2005. - 34 p.
4. Azhazha V.M., Lavrinenko S.D., V'yugov P.N., Lindt K.A., Mukhachev A.P., Pylypenko M.M. Zirconium and its alloys. Production technology, application field. Kharkov: NSC KIPT, 1998. - 88 p.
5. Database PCPDF // International Center for Diffraction Data, 1996. - P. 20-23.
6. Serykh V.P., Serykh L.M. Computer Methods in X-ray diffraction of polycrystalline: Review. Kharkov: NSC KIPT, 2004. - 76 p.
7. Bykov D.V., Klimov S.V., Panina E.G. The results of studies of low temperature activation process non-evaporable getters based on titanium and zirconium // Second National Workshop on non-evaporable getters. – Moscow, 1991. - P.10 – 13.
8. Dantzer P., Orgaz E. Thermodynamics of hydride chemical heat pump – II. How to select a pair of alloys // Int. J. Hydrogen Energy. – 1986. – Vol.11. – No.12. – P. 797- 806.
9. Bykov D.V., Kondrashova O.I., Smirnov S.N., Klimov S.V. The investigation of the activation process Ti non-evaporable getters: Review NSC, MIEM, 1989. - P. 9 – 25.
10. Mavrikakis M., Schwank W., Gland L. The effect of exposure time and pressure on the temperature-programmed desorption spectra of system with bulk states // Surface Science. – 1996. – Vol. 355. – P. L385 – L392.
11. Beckman I.N., Gabisov I.E., Kompanietz T.N., etc. The investigation of the hydrogen permeability in manufacturing technique of electronic products: Electronics review. M.: CRI «Electronics». – 1985. - 66 p. (Line: Technology, industry engineering and facility. - Vol.1. - P. 1084)
12. Tazhibaeva I.L., Beckman I.N., Shestakov V.P., Rudenko N.V. // Physico-chemical mechanics of material. – 1985. – Vol. 21. – No.1. - P. 18-23
13. Ageev A.V., Beckman I.N., Burmistrova O.P. et al. Hydrogen interaction with metals. – M.: Nauka, 1987. - 294 p.
14. Gorodetsky A.E., Zakharov A.P., Sharapov V.M. // Journal of Physical Chemistry. – 1980. – Vol. 64. - Iss. I.S. – P. 2874 – 2881.