

АВТОМАТИЗОВАНІ СИСТЕМИ УПРАВЛІННЯ НА ТРАНСПОРТІ

UDC 656.256.3 : 625.162. 4

V. I. HAVRYLIUK^{1*}, O. M. VOZNYAK^{2*}, V. V. MELESHKO^{3*}

^{1*}Dep. «Automation, Telemechanics and Communications», Dnipropetrovsk National University of Railway Transport named after Academician V. Lazaryan, Lazaryan St., 2, Dnipropetrovsk, Ukraine, 49010, tel. +38 (056) 373 15 04, e-mail diitats@mail.ru, ORCID 0000-0001-9954-4478

^{2*}Dep. «Transportation Technology», Lviv branch of the Dnipropetrovsk National University of Railway Transport named after Academician V. Lazarian, I. Blazhkevich St., 12a, Lviv, Ukraine, 79052, tel. 38 (032) 267 99 74, e-mail ovozom@gmail.com, ORCID 0000-0002-7163-9026

^{3*}Head Dep. «Automation, Telemechanics and Communications», Ukrzaliznytsia, Tverska St., 5, Kyiv, Ukraine, 03680, e-mail soyuz_at@mail.ru, ORCID 0000-0001-6833-964X

IMPROVING THE POSITIONING ACCURACY OF TRAIN ON THE APPROACH SECTION TO THE RAILWAY CROSSING

Purpose. In the paper it is necessary to analyze possibility of improving the positioning accuracy of train on the approach section to crossing for traffic safety control at railway crossings. **Methodology.** Researches were performed using developed mathematical model, describing dependence of the input impedance of the coded and audio frequency track circuits on a train coordinate at various values of ballast isolation resistances and for all usable frequencies. **Findings.** The paper presents the developed mathematical model, describing dependence of the input impedance of the coded and audio-frequency track circuits on the train coordinate at various values of ballast isolation resistances and for all frequencies used in track circuits. The relative error determination of train coordinate by input impedance caused by variation of the ballast isolation resistance for the coded track circuits was investigated. The values of relative error determination of train coordinate can achieve up to 40-50 % and these facts do not allow using this method directly for coded track circuits. For short audio frequency track circuits on frequencies of continuous cab signaling (25, 50 Hz) the relative error does not exceed acceptable values, this allow using the examined method for determination of train location on the approach section to railway crossing. **Originality.** The developed mathematical model allowed determination of the error dependence of train coordinate by using input impedance of the track circuit for coded and audio-frequency track circuits at various frequencies of the signal current and at different ballast isolation resistances. **Practical value.** The authors propose the method for train location determination on approach section to the crossing, equipped with audio-frequency track circuits, which is a combination of discrete and continuous monitoring of the train location.

Keywords: railway crossings; automatic crossing signaling; train coordinate control

Introduction

Railway crossings as crossing places in the same level of the railway roadbed and highway are one of the most dangerous areas for the rail and vehicular traffic. Safety control at railway crossings is one of the most acute questions of the general problem for traffic safety on the railways. In

accordance with the conducted analysis, the number of road traffic accidents at railway crossings in recent years has decreased significantly in Ukraine, but is still quite large and is accompanied by significant material and human losses (Fig. 1). Analysis of accidents at railway crossings in different categories (Fig. 2) showed that their considerable

АВТОМАТИЗОВАНІ СИСТЕМИ УПРАВЛІННЯ НА ТРАНСПОРТІ

quantity (more than 60%) occurred at crossings equipped with automatic crossing signaling (ACS) without a crossing tender.

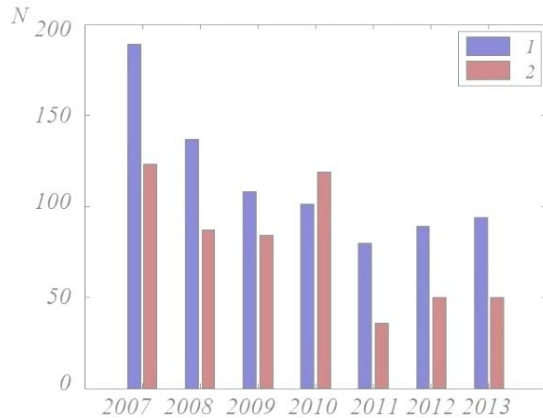

Fig. 1. The total number of road traffic accidents at Ukrainian railway crossings (1) and the number of victims (2) during 2007-2013 years

A similar situation is typical for other countries. For example, in Europe more than 300 deaths occur per year due to accidents at railway crossings [10], and most of them happen at open railway crossings.

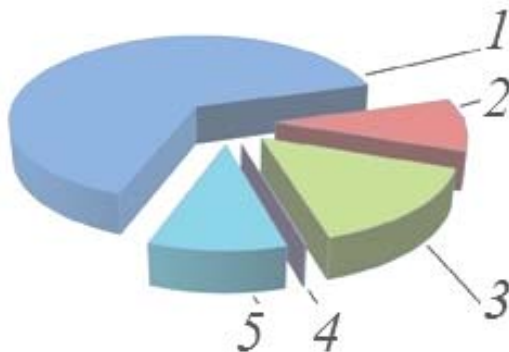

Fig. 2. Distribution of road traffic accidents by types of railway crossings:

- 1 – unmanned, equipped with ACS; 2 – unmanned, without ACS; 3 – with man on duty and signalling; 4 – with man on duty and without signalling; 5 – outside of a railway crossing

The main cause of road traffic accidents at railway crossings is noncompliance with rules by drivers of vehicles, namely, transit through the crossing after the pre-alarm application before the approaching train.

For the timely detection of obstacles before the approaching train at railway crossings many methods were proposed, including ultrasonic detectors usage [11], radars [9], satellite positioning [16] and other sensor devices [8,17], as well as using video

surveillance the rail crossing zone [12,13,15] with information transfer to the train driver.

Vehicles entry at the railway crossing after the pre-alarm application in some cases is provoked with unreasonably high latency time of train's passage, which can be 12 minutes or more. This is due to the fact that the actual motion speed of different trains can vary greatly, while ACS switching occurs at the train entry to the approaching area with the fixed length, which is calculated on the maximum speed of the train.

Thus, in order to improve movement safety at railway crossings it is necessary to use additional means of control, allowing to inspect the zone vacancy of railway crossing, as well as the section of approaching the train to the crossing with automatic determination of train position and speed.

A great number of methods and devices of automatic crossing signaling based on the actual speed of the trains and coordinates at the approaching section, that are determined by the signals from the point sensors of different design, placed on the approaching section to the crossing are described in the literature. However, none of these devices was not widely used due to the lack of functional safety. It is worth mentioning the measuring methods of train coordinates on the approach section to the crossing, based on changes of parameters control of the rail line during the train movement on it. The [2] proposed a method based on test signaling supply in to the rail line, [6, 14] proposed to measure the distance up to cuts on the marshaling yard, based on signal processing of track circuits using the states classifier. The authors [4, 5] proposed to determine the train coordinates by input resistance of the track circuit (TC), on which there is a train. Since the accuracy of these methods is significantly affected by the ballast insulation resistance of rail lines, the authors [4-6, 14] offered to analyze the measured signals and parameters of track circuits using different state classifiers of track circuits. However, complete research for the changes impact of ballast insulation resistance on the on train positioning accuracy has not been studied sufficiently.

Purpose

Purpose of this paper is improving the positioning accuracy of trains on the approach section to the railway crossing that eventually will increase traffic safety at them.

Methodology

Research were conducted with the mathematical model method on the developed model that describes the input impedance dependence of the coded and audio-frequency track circuits on the train coordinate at different values of the ballast insulation resistance for all signal current frequencies that are presently used in track circuits.

Mathematical model. Equivalent circuits of the coded track circuit with signal circuit frequency of 25 and 50 Hz and jointless audio-frequency track circuit with frequencies of 25, 50, 420, 480, 580, 720, 780 Hz in the presence of a train on it (i.e. in shunt mode operation) are presented in Fig. 3.

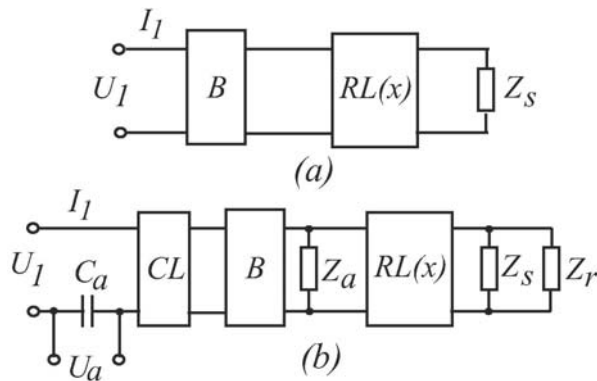

Fig. 3. Equivalent circuits of the coded (a) and audio-frequency (b) track circuits in a shunt mode

In the figure, there are following designations: – U_1, I_1 – input voltage and current at the output, supplying TC (transformer, frequency converter or track filter for AFTC); U_a, I_a – voltage and coded current of automatic signalling for audio frequency track circuits; C_a – capacitor in the current supply circuit of cab signaling; CL – four-pole network, corresponding to the cable line for audio frequency track circuits; B – four-pole network, including all equipment of TC supply end, located in the track box or the relay case near a rail line (transformer, impedance-bond resistors, capacitors in accordance with electric circuit of TC [3]); Z_a – the input impedance of the adjacent track circuit (for jointless track circuits); $RL(x)$ – four-pole network, corresponding to the rail line with the movable unit (train) at a distance x from the supply end; Z_s – impedance of train shunt; Z_r – impedance of the rail line after the movable unit. Parameters of RC elements and coefficients of four-pole network for

matrix in A – form are taken from [3]. The primary parameters of the cable and the rail lines at the frequency of the current signal were converted into the coefficients of four-pole network similarly (as in) [1, 3, 7]. The general matrix accordingly to the equivalent circuits (Fig. 1) was calculated as the matrix product of all four-pole network, included in it

$$\underline{M}_0 = \prod_i \underline{M}_i. \quad (1)$$

The input impedance of the track circuit with the movable shunt on it is found by formula:

$$\underline{Z}_i = \frac{\underline{M}(1,1)R_s + \underline{M}(1,2)}{\underline{M}(2,1)R_s + \underline{M}(2,2)}. \quad (2)$$

The above mentioned mathematical description is implemented in MatLab. The selected variable parameters included the following: signal current frequency f equal to 25, 50, 420, 480, 580, 720 or 780 Hz; length of the rail line L and the current coordinate of the movable unit $x = 0..L$, and the ballast insulation resistance r_i .

Findings

The simulation resulted in obtained dependences of the input impedance of track circuit in shunt mode $Z_{inp}(x, f, r_i)$ on TC parameters. Simulation was performed for the coded track circuits with signal current frequency of 25 Hz, length of 2.5 km and 50 Hz, length of 2.6 km at two values of ballast insulation resistance r_i , equal 1 and 50 Ohm/km. For audio-frequency track circuits simulation was performed for signal current frequency of 25, 50, 420, 480, 580, 720 and 780 Hz at a RC length of 0.3 km and ballast insulation resistance r_i 0.8 and 50 Ohm / km. Cable line length is taken equal to 1 km.

The simulation obtained dependences of the input impedance modulus $abs(Z_{inp})$ from train coordinate $x = 0..L$ are presented in Fig. 4. The figure shows that at distance up to the train $x \leq 1 km$ resistance impact r_i on value $abs(Z_{inp})$ is not significant, but when x is increased this impact becomes essential that does not allow determining the train coordinate x by input

АВТОМАТИЗОВАНІ СИСТЕМИ УПРАВЛІННЯ НА ТРАНСПОРТІ

impedance of track circuits $Z_{inp}(x, f, r_i)$ with sufficient accuracy for practical usage.

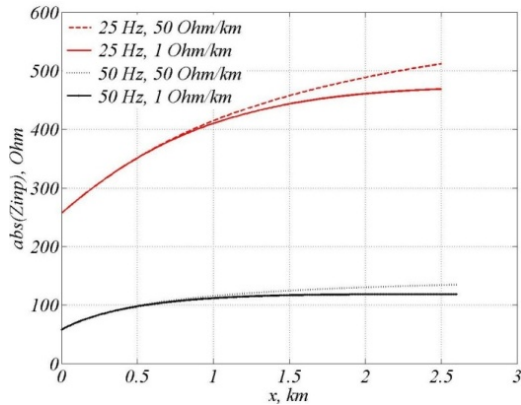

Fig. 4. Dependences of the input impedance modulus of the coded track circuits on the coordinate x

To study the impact of ballast insulation resistance changes r_i on the train coordinate accuracy x accordingly value $Z_{inp}(x, f, r_i)$ for each value $Z_{inp}(x, f, r_i)$ at given frequency f the values of the corresponding train coordinate were calculated at two values of ballast insulation resistance r_i , equal 50 and 1 Ohm/km. Difference between these values

$$\text{deltax} = x_1(r_i = 50) - x_2(r_i = 1)$$

characterizes the absolute error in determining the coordinate x , due to the change of ballast insulation resistance.

Dependence deltax on x is presented in Fig. 5.

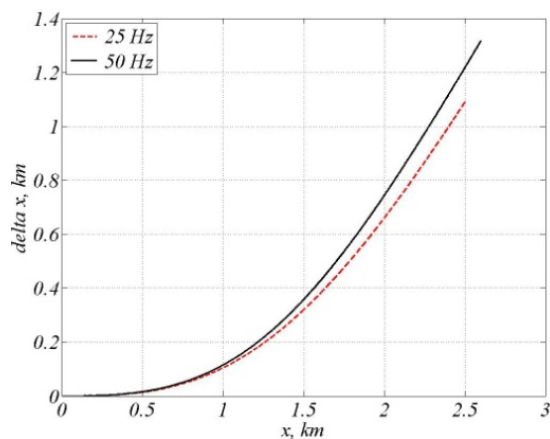

Fig. 5 The dependence of the absolute error deltax on the coordinate x

The figure shows that absolute error in determining the coordinate deltax increases significantly with raise $x > 0,5$ km and at maximum value $x = L$ the relative error is $\sim 40-50$ %.

Thus, it can be concluded that the direct use of the method for determining the train coordinate accordingly the input impedance of the coded track circuits does not provide the necessary accuracy for practical use due to the significant impact change of ballast insulation resistance. To reduce error of the coordinate measurement in [4, 5] proposed the use of the additional measurement results processing using the classifier of track circuits states.

For the coordinate $x \leq 0,5$ km error of measurements x accordingly input impedance is not significant one.

Based on research the paper proposed the method of accuracy increase of determining the train coordinate on approach section to the railway crossing, equipped with audio-frequency track circuits. It comprises the simultaneous usage of discrete and continuous monitoring of the train's position. Discrete monitoring is carried out by signals from track relays of audio frequency track circuits in accordance with the control scheme concerning sequence of occupancy and clearing the track circuits. Continuous monitoring is based on the input resistance dependence of audio frequency track circuits on the train coordinate.

This method is implemented due to widespread introduction of automatic block signalling with audio frequency track circuits instead of the numeric coded automatic block signalling, occurring in recent times, supports implementation of this method. According to typical materials for the crossing signaling design for sections, equipped with automatic block signaling with audio frequency track circuits, for crossing signaling operation for each track near crossing, two track circuits, usually with a common feed end and with a frequency of 720 Hz for one track and 780 Hz for a different one, length of at least 150 are provided. The rest of approach section to the railway crossing in the right and the wrong directions includes several audio frequency track circuits. Prior to approaching section audio-frequency track circuit also has a short length and frequency of 720 or 780 Hz, which allow reducing the area of the additional shunting, and, respectively, to record more

АВТОМАТИЗОВАНІ СИСТЕМИ УПРАВЛІННЯ НА ТРАНСПОРТІ

precisely the entry of the train on the approach section.

Fig. 6 presents the dependences of input impedance modulus $abs(Z_{inp})$ audio frequency track circuits (TC) on coordinate x train for signal current with frequencies of 420, 480, 580, 720, 780 Hz and for ACS current, frequency of 25 и 50 Hz at $r_i = 0,8 \text{ Ohm/km}$ are presented in Fig. 6.

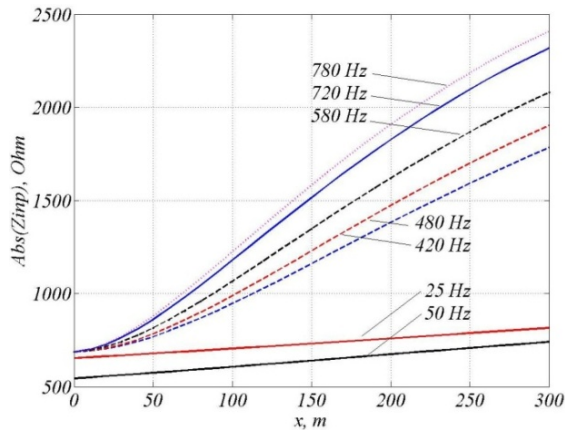

Fig. 6. Dependencies of input impedance modulus $abs(Z_{inp})$ of audio-frequency track circuits on x for different frequencies

As it can be seen from the figure monotone dependence $abs(Z_{inp})$ on x allow using it to determine the train coordinates at all tested frequencies. The resolution capability of the method depends on change rate of the input impedance of track circuit Z_{inp} by variation x . To evaluate rate of change Z_{inp} from x at different frequencies the derivative from Z_{inp} upon x was calculated

$$dif(abs(Z_{inp})) = \frac{\partial[abs(Z_{inp})]}{\partial x}.$$

Fig. 7 presents the dependence of derivative $dif(abs(Z_{inp}))$ on x . One can see that graph $dif(abs(Z_{inp}))$ takes fairly large values, which increase with the frequency increase and decrease of the distance to the train.

To study the impact of change of the ballast insulation resistance $Z_{inp}(x, r_i)$ we bring into consideration value, equal to the difference between the input impedance of the TC at the two extreme values of ballast insulation resistance $r_i = 0,8 \text{ u } 50 \text{ Ohm/km}$

$$Z_{dif}(x) = Z_{inp}(x, 50) - Z_{inp}(x, 1).$$

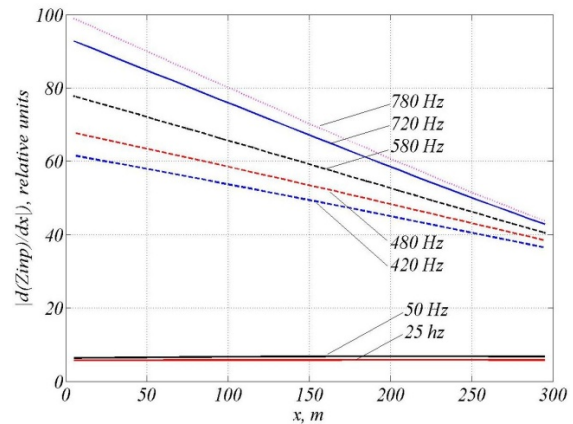

Fig. 7. Dependence of the derivative $dif(abs(Z_{inp}))$ on x for the different frequencies

Fig. 8 presents the dependence Z_{dif} on the coordinate x for frequencies $f = 25, 50, 420, 480, 580, 720, 780 \text{ Hz}$ is presented in Fig. 8. From this Figure one can see, that value $abs(Z_{dif})$ is significantly increased by raising the coordinate x and signal current frequency. It should be noted, that obtained values are large enough $abs(Z_{dif})$ and they do not fully characterize the error of measurement. To characterize the relative measurement error, let us consider the relative change of the TC input impedance $Z_{inp}(x, r_i)$, caused by changes of the ballast insulation resistance

$$Z_r(x) = \frac{(Z_{inp}(x, 50) - Z_{inp}(x, 0,8))}{Z_{inp}(0,8)}.$$

Calculated dependence Z_r on x is presented in Figure 9. From the above dependence one can be seen that relative values of change $Z_{inp}(x, r_i)$ at variation of ballast insulation resistance have acceptable for practical use values, equal $\leq 1\%$, only for frequencies of 25 and 50 Hz. It may be concluded that on the short track circuits is possible direct determination of train coordinate by their input impedance at operation frequencies of automatic cab signalling, i.e. 25 and 50 Hz, since the relative measurement error caused by the change of ballast insulation resistance at these frequencies, does not exceed the allowable values for practical use.

АВТОМАТИЗОВАНІ СИСТЕМИ УПРАВЛІННЯ НА ТРАНСПОРТІ

Measurement error of train coordinate upon the input resistance of track circuits on tonal frequencies is significant and these results application to determine the position of the train is only possible after the appropriate intellectual processing of measurement results.

Since the input impedance of track circuits is a complex quantity, the behavior of each of its components is of interest, depending on the train coordinate, frequency and the ballast insulation resistance to select the most suitable complex impedance component for the practical use. Fig. 10 presents the graphs of complex impedance compo-

nents of the track circuit, namely, $Abs(\underline{Z}_r)$ modulus, $Arg(\underline{Z}_r)$ argument, real $Re(\underline{Z}_r)$ and imaginary part $Im(\underline{Z}_r)$ from frequency and train coordinate. From the analysis of the mentioned graphs one can conclude that the most appropriate value for determining the coordinates x is considered above $Abs(\underline{Z}_r)$ modulus, since the rest components dependences of complex value of the input impedance of track circuits on coordinates x has more complex nature, which may lead to ambiguity of measurement results interpretation.

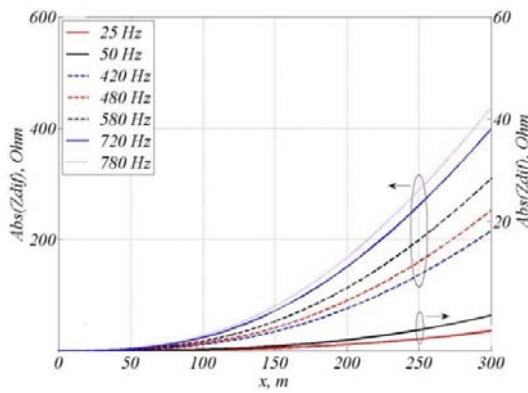

Fig. 8. Dependence of $Abs(\underline{Z}_{dif})$ on x for different frequencies

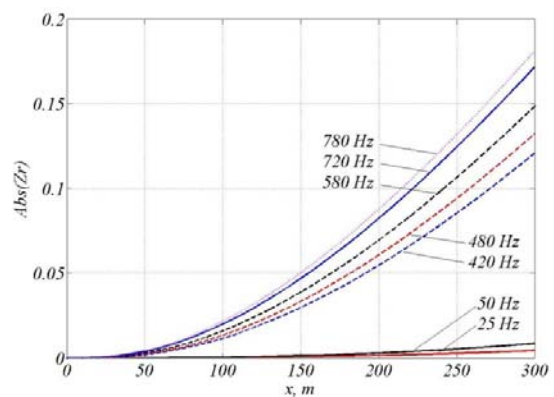

Fig. 9. Dependence of $Abs(\underline{Z}_r)$ on x for different frequencies

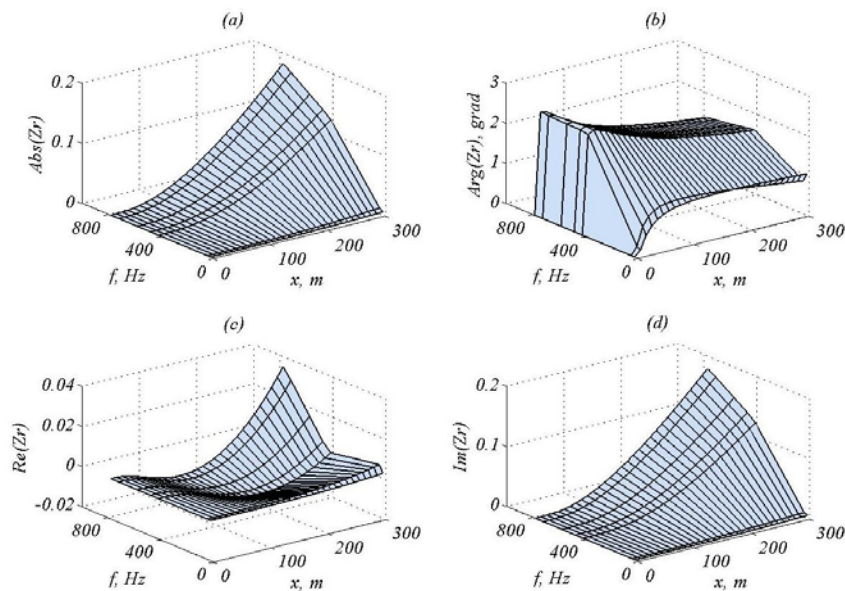

Fig. 10. Dependence of $Abs(\underline{Z}_r)$ module, $Arg(\underline{Z}_r)$ argument, real $Re(\underline{Z}_r)$ and imaginary $Im(\underline{Z}_r)$ part of the impedance \underline{Z}_r on the frequency f and coordinate x

The results obtained at simulation for other lengths of track circuits and of cable line have shown that the above considered regularities are performed for them too.

Originality and practical value

The developed mathematical model allowed determination of the error dependence of the train coordinate upon the input impedance of the track circuit for coded and audio-frequency track circuits at various frequencies of the signal current and ballast insulation resistance.

The paper proposed the method for train location determination on approach section to the crossing, equipped with audio-frequency track circuits, which is a combination of discrete and continuous monitoring of the train location. Discrete monitoring is carried out by signals from track relays of audio-frequency track circuits in accordance with the control scheme concerning sequence of occupancy and clearing the track circuits. Continuous monitoring of train position is controlled with the input resistance of audio-frequency track circuits.

Conclusions

1. A mathematical model was developed; it describes the dependence of the input impedance of coded and audio-frequency track circuits on the train coordinate at different values of the ballast insulation resistance for all usable frequencies of current signal in track circuits.

2. Relative error of detecting the coordinates of the train by input impedance of the coded track circuits due to the change of ballast insulation resistance was determined. It can reach 40-50%, which makes impossible a straight-forward adaptation of a method for determining the coordinates of the train by the input impedance of the coded track circuits.

3. For the audio-frequency track circuits at frequencies of automatic cab signaling the relative error in determining the coordinate of the train by the input impedance does not exceed the acceptable values, it allows using this method to determine the train location on approach section to the railway crossing.

LIST OF REFERENCE LINKS

1. Гаврилюк, В. И. Испытания новых типов подвижного состава на электромагнитную совместимость с устройствами сигнализации и связи / В. И. Гаврилюк, В. И. Щека, В. В. Мелешко // Наука та прогрес транспорту. – 2015. – № 5 (59). – С. 7–15. doi: 10.15802/stp2015/55352.
2. Грачев, Г. Н. Применение метода импульсного зондирования для организации переездной сигнализации / Г. Н. Грачев, М. Б. Гуменик. // Автоматика, телемеханика и связь. – 1997. – № 11. – С. 28–30.
3. Рельсовые цепи магистральных железных дорог : справочник / В. С. Аркатов, Ю. В. Аркатов, С. В. Казеев, Ю. В. Ободовский. – Москва : Миссия-М. – 2006. – 496 с.
4. Тарасов, Е. М. Выбор признаков и решающих правил при распознавании состояний рельсовых линий сортировочных горок / Е. М. Тарасов, М. В. Трошина // Вестн. УГАТУ. – 2012. – Т. 16, № 3 (48). – С. 194–197.
5. Тарасов, Е. М. Определение вида решающей функции классификатора координат вагонов // Изв. академии управления: теория, стратегии, инновации. – 2013. – № 1 (14). – С. 54–57.
6. Gavriljuk, V. Investigation of correlation measuring method accuracy for two types of test signals / V. Gavriljuk, R. Rybalka, V. Bezrukov // Transport problems. – 2008. – Vol. 3. – Iss. 4, pt. 1. – P. 33–38.
7. Havryliuk, V. I. Electrical impedance of traction rails at audio frequency range / V. I. Havryliuk, V. V. Meleshko // Інформ.-керуючі системи на заліз. трансп. – 2015. – № 2. – P. 31–36.
8. Ku, B. Y. Grade-Crossing Safety / B. Y. Ku // IEEE Vehicular Technology Magazine. – 2010. – Vol. 5. – Iss. 3. – P. 75–81. doi: 10.1109/MVT.2010.938274.
9. Lohmeier, S. P. Development of an ultra-wideband radar system for vehicle detection at railway crossings / S. P. Lohmeier, R. Rajaraman, V. C. Ramasami // Proc. of IEEE Intern. Geoscience and Remote Sensing Symposium (24.06–28.06.2002). – 2002. – Vol. 6. – P. 3692–3694. doi: 10.1109/IGARSS.2002.1027293.
10. Mekki, A. Validation of a new functional design of automatic protection systems at level crossings with model-checking techniques / A. Mekki, M. Ghazel, A. Toguyeni // IEEE Transactions on Intelligent Transportation Systems. – 2012. – Vol. 13. – Iss. 2. – P. 714–723. doi: 10.1109/TITS.2011.2178238.
11. Obstruction detector using ultrasonic sensors for upgrading the safety of a level crossing / S. Kazutoshi, H. Arai, T. Shimizu, M. Takada // Proc. of

АВТОМАТИЗОВАНІ СИСТЕМИ УПРАВЛІННЯ НА ТРАНСПОРТІ

- the Intern. Conference on Developments in Mass Transit Systems. – London, 1998. – P. 190–195. doi: 10.1049/cp:19980140.
12. Pu, Y.-R. Study of moving obstacle detection at railway crossing by machine vision / Y.-R. Pu, Li-W. Chen, S.-H. Lee // Informational Technology Journal. – 2014. – Vol. 13. – Iss 16. – P. 2611–2618. doi: 10.3923/itj.2014.2611.2618.
 13. Road sign recognition by single positioning of space-variant sensor window / D. G. Shaposhnikov, L. N. Podladchikova, A. V. Golovan, N. A. Shevtsova // Proc. of the 15th Intern. Conference on Vision Interface. – Calgary, 2002. – P. 213–217.
 14. Rybalka, R. Identification method of linear dynamic systems with spectrum correction procedure used / R. Rybalka, V. Gavriljuk, V. Bezrukov // Advances in Transport Systems Telematics. – Warszawa : Wydawnictwa komunikacji i łączności, 2009. – P. 229–236.
 15. Rybalka, R. Method for pre-processing of level crossing image / R. Rybalka, K. Honcharov // Transport problems. – 2015. – Vol. 10. – Iss.1. – P. 79–86.
 16. Sobolev, Yu. Principles of railway crossing signaling control using satellite systems of navigation / Yu. Sobolev, A. Bojnik // Eastern-European J. of Enterprise Technologies. – 2003. – № 1. – P. 21–28.
 17. Takeda, T. Improvement of railroad crossing signals / T. Takeda // Proc. of 1999 IEEE/IEEEJ/JSAT Intern. Conference on Intelligent Transportation Systems (05.10–08.10.1999). – Tokyo, 1999. – P. 139–141. doi: 10.1109/ITSC.1999.821042.

В. І. ГАВРИЛЮК^{1*}, О. М. ВОЗНЯК^{2*}, В. В. МЕЛЕШКО^{3*}

^{1*}Каф. «Автоматика, телемеханіка та зв'язок», Дніпропетровський національний університет залізничного транспорту імені академіка В. Лазаряна, вул. Лазаряна, 2, Дніпропетровськ, Україна, 49010, тел. +38 (056) 373 15 04, ел. пошта diitats@mail.ru, ORCID 0000-0001-9954-44781

^{2*}Каф. «Транспортні технології», Львівська філія Дніпропетровського національного університету залізничного транспорту імені академіка В. Лазаряна, вул. І. Блакєвич, 12а, Львів, Україна, 79052, тел. +38 (032) 267 99 74, ел. пошта ovozom@gmail.com, ORCID 0000-0002-7163-9026

^{3*}Головне управління автоматики, телемеханіки та зв'язку ДП «Укрзалізниця», вул. Тверська, 5, Київ, Україна, 03680, ел. пошта soyuz_at@mail.ru, ORCID 0000-0001-6833-964X

ПІДВИЩЕННЯ ТОЧНОСТІ ВИЗНАЧЕННЯ ПОЛОЖЕННЯ ПОЇЗДА НА ДІЛЯНЦІ НАБЛИЖЕННЯ ДО ПЕРЕЇЗДУ

Мета. У статті необхідно проаналізувати можливість підвищення точності визначення положення поїзда на ділянці наближення до переїзду для забезпечення безпеки руху на залізничних переїздах. **Методика.** Дослідження проведені з використанням розробленої математичної моделі, що описує залежність вхідного імпедансу кодових і тональних рейкових кіл (РК) від координати поїзда при різних значеннях опору ізоляції баласту для всіх використовуваних частот. **Результати.** Розроблено математичну модель, що описує залежність вхідного імпедансу кодових і тональних рейкових кіл від координати поїзда при різних значеннях опору ізоляції баласту та всіх використовуваних в РК частот сигнального струму. Досліджено залежність відносної похибки визначення координати поїзда по вхідному імпедансу кодових рейкових кіл, яка обумовлена зміною опору ізоляції баласту. Значення відносної похибки визначення координати поїзда можуть досягати 40–50 %, що не дозволяє безпосередньо застосовувати цей спосіб для кодових рейкових кіл. Для коротких тональних рейкових кіл на частотах автоматичної локомотивної сигналізації безперервного типу (25, 50 Гц) відносна похибка визначення координати поїзда по вхідному імпедансу не перевищує допустимі значення. Це дозволяє використовувати розглянутий спосіб для визначення місця розташування поїзда на ділянці наближення до переїзду. **Наукова новизна.** На основі розробленої математичної моделі досліджена залежність похибки визначення координати поїзда по вхідному імпедансу рейкового кола для кодових і тональних рейкових кіл при різних частотах сигнального струму та при різних опорах ізоляції баласту. **Практична значимість.** Авторами запропоновано метод визначення положення поїзда на ділянці наближення до переїзду для перегонів, обладнаних тональними рейковими колами, який заснований на використанні дискретного та безперервного контролю координати поїзда.

Ключові слова: залізничні переїзди; автоматична переїзна сигналізація; контроль координати поїзда

АВТОМАТИЗОВАНІ СИСТЕМИ УПРАВЛІННЯ НА ТРАНСПОРТІ

В. И. ГАВРИЛЮК^{1*}, О. М. ВОЗНЯК^{2*}, В. В. МЕЛЕШКО^{3*}

^{1*}Каф. «Автоматика, телемеханика и связь», Днепропетровский национальный университет железнодорожного транспорта имени академика В. Лазаряна, ул. Лазаряна, 2, Днепропетровск, Украина, 49010, тел. +38 (056) 3731504, эл. почта diitats@mail.ru, ORCID 0000-0001-9954-4478

^{2*}Каф. «Транспортные технологии», Львовский филиал Днепропетровского национального университета железнодорожного транспорта имени академика В. Лазаряна, ул. И. Блажкевич, 12а, Львов, Украина, 79052, тел. +38 (032) 267 99 74, эл. почта ovozom@gmail.com, ORCID 0000-0002-7163-9026

^{3*}Главное управление автоматики, телемеханики и связи ГП «Укрзализныця», ул. Тверская, 5, Киев, Украина, 03680, эл. почта soyzuz_at@mail.ru, ORCID 0000-0001-6833-964X

ПОВЫШЕНИЕ ТОЧНОСТИ ОПРЕДЕЛЕНИЯ ПОЛОЖЕНИЯ ПОЕЗДА НА УЧАСТКЕ ПРИБЛИЖЕНИЯ К ПЕРЕЕЗДУ

Цель. В статье необходимо проанализировать возможность повышения точности определения положения поезда на участке приближения к переезду для обеспечения безопасности движения на железнодорожных переездах. **Методика.** Исследования проведены с использованием разработанной математической модели, описывающей зависимость входного импеданса кодовых и тональных рельсовых цепей (РЦ) от координаты поезда при различных значениях сопротивления изоляции балласта для всех используемых частот. **Результаты.** Разработана математическая модель, описывающая зависимость входного импеданса кодовых и тональных рельсовых цепей от координаты поезда при различных значениях сопротивления изоляции балласта и всех используемых в РЦ частот сигнального тока. Исследована зависимость относительной погрешности определения координаты поезда по входному импедансу кодовых рельсовых цепей, обусловленная изменением сопротивления изоляции балласта. Значения относительной погрешности определения координаты поезда могут достигать 40–50 %, что не позволяет непосредственно применять этот способ для кодовых рельсовых цепей. Для коротких тональных рельсовых цепей на частотах автоматической локомотивной сигнализации непрерывного типа (25, 50 Гц) относительная погрешность определения координаты поезда по входному импедансу не превышает допустимые значения. Это позволяет использовать рассмотренный способ для определения местоположения поезда на участке приближения к переезду. **Научная новизна.** На основе разработанной математической модели исследована зависимость погрешности определения координаты поезда по входному импедансу рельсовой цепи для кодовых и тональных рельсовых цепей при различных частотах сигнального тока и при различных сопротивлениях изоляции балласта. **Практическая значимость.** Авторами предложен метод определения положения поезда на участке приближения к переезду для перегонов, оборудованных тональными рельсовыми цепями, который основан на использовании дискретного и непрерывного контроля координаты поезда.

Ключевые слова: железнодорожные переезды; автоматическая переездная сигнализация; контроль координаты поезда

REFERENCES

1. Havryliuk V.I., Shcheka V.I., Meleshko V.V. Ispytaniya novykh tipov podvizhnogo sostava na elektromagnitnyu sovместimost s ustroystvami signalizatsii i svyazi [Testing new types of rolling stock for electromagnetic compatibility with signaling and communication devices]. *Nauka ta prohres transportu – Science and Transport Progress*, 2015, no. 5 (59), pp. 7-15. doi: 10.15802/stp2015/55352.
2. Grachev G.N., Gumenik M.B. Primeneniye metoda impulsnogo zondirovaniya dlya organizatsii pereydznoy signalizatsii [Pulse sounding method application for the organization of crossing signaling]. *Avtomatika telemechanika i svyaz – Automation, Telecontrol and Communication*, 1997, no. 11, pp. 28-30.
3. Arkatov V.S., Arkatov Yu.V., Kazeyev S.V., Obodovskiy Yu.V. *Relsovyye tsepi magistralnykh zheleznykh dorog* [Track circuits of main railways]. Moscow, LLC «Missiya-M» Publ., 2006. 496 p.
4. Tarasov Ye.M., Troshina M.V. Vybor priznakov i reshayushchikh pravil pri raspoznavanii sostoyaniy relsovykh liniy sortirovochnykh gorok [Features selection and decision rules for recognition of rail lines on marshalling yards]. *Vestnik Ufimskogo gosudarstvennogo aviatsionnogo tekhnicheskogo universiteta* [Bulletin of Ufa State Aviation Technical University], 2012, vol. 16, no. 3 (48), pp. 194-197.
5. Tarasov Ye.M. Opredeleniye vida reshayushchey funktsii klassifikatora koordinat vagonov [Defining the type of decision function of coordinate cars classifier]. *Izvestiya akademii upravleniya: teoriya, strategiya, innovatsii – News of Management Academy: Theory, Strategy and Innovation*, 2013, no. 1 (14), pp. 54-57.

АВТОМАТИЗОВАНІ СИСТЕМИ УПРАВЛІННЯ НА ТРАНСПОРТІ

6. Gavriljuk V., R. Rybalka, V. Bezrukov. Investigation of correlation measuring method accuracy for two types of test signals. *Transport problems*, 2008, vol. 3, issue 4, Part 1, pp. 33-38.
7. Havryliuk V.I., Meleshko V.V. Electrical impedance of traction rails at audio frequency range. *Informatsiino-keruiuchi systemy na zaliznychnomu transp – Information and Control Systems on the Railway Transport*, 2015, no. 2, pp. 31-36.
8. Ku B.Y. Grade-Crossing Safety. *IEEE Vehicular Technology Magazine*, 2010, vol. 5, issue 3, pp. 75-81. doi: 10.1109 /MVT.2010. 938274
9. Lohmeier S.P., Rajaraman R., Ramasami V.C. Development of an ultra-wideband radar system for vehicle detection at railway crossings. Proc. of IEEE Intern. Geoscience and Remote Sensing Symposium (24.06-28.06.2002). 2002, vol. 6. pp. 3692-3694. doi: 10.1109/IGARSS.2002.1027293.
10. Mekki A., Ghazel M., Toguyeni A. Validation of a new functional design of automatic protection systems at level crossings with model-checking techniques. *IEEE Transactions on Intelligent Transportation Systems*, 2012, vol. 13, issue 2, pp. 714-723. doi: 10.1109/TITS. 2011. 2178238.
11. Kazutoshi S., Arai H., Shimizu T., Takada M. Obstruction detector using ultrasonic sensors for upgrading the safety of a level crossing. Proc. of the Intern. Conference on Developments in Mass Transit Systems. London, 1998, pp. 190-195. doi: 10.1049/cp:19980140.
12. Pu Y.-R., Chen Li-W., Lee S-H. Study of moving obstacle detection at railway crossing by machine vision // Y.-R. Pu. *Informational Technology Journal*, 2014, vol. 13, issue 16, pp. 2611-2618. doi: 10.3923/itj.2014.2611.2618.
13. Shaposhnikov D.G., Podladchikova L.N., Golovan A. V., Shevtsova N.A. Road sign recognition by single positioning of space-variant sensor window. Proc. of the 15th Intern. Conference on Vision Interface. Calgary, 2002, pp. 213-217.
14. Rybalka R., Gavriljuk V., Bezrukov V. Identification method of linear dynamic systems with spectrum correction procedure used. *Advances in transport systems telematics*. Warszawa, Wydawnictwa komunikacji i lacznosci Publ., 2009, pp. 229-236.
15. Rybalka R., Honcharov K. Method for pre-processing of level crossing image. *Transport problems*, 2015, vol. 10, issue 1, pp. 79-86.
16. Sobolev Yu., Bojnik A. Principles of railway crossing signaling control using satellite systems of navigation. *Eastern-European Journal of Enterprise Technologies*, 2003, no. 1, pp. 21-28.
17. Takeda T. Improvement of railroad crossing signals. Proc. of 1999 IEEE/IEEJ/JSAI Intern. Conference on Intelligent Transportation Systems (05.10-08.10.1999). Tokyo, 1999, pp. 139-141. doi: 10.1109/ITSC.1999.821042.

Prof. A. B. Boinik, Sc. Tech. (Ukraine); Prof. V. V. Skalozub, Sc. Tech. (Ukraine) recommended this article to be published

Accessed: Dec. 12, 2015

Received: Feb. 21, 2016